

X **XYRON**[®] **PRO** 1255

U S E R ' S G U I D E

Adhesive Application & Laminating System



The XM1255 is an economical and easy to use document finishing system. This versatile and non-electric system has been designed to laminate or apply mounting adhesive to a variety of media. The same system is capable of laminating, selectively applying adhesive or applying laminate and adhesive at the same time. With the XM1255, documents are easily laminated or can be transformed into signs, stickers or labels instantly. The machine and supplies are compatible with all types of computer-printed media including laser, inkjet, color and thermal in a wide range of material sizes and thickness.

FEATURES & FUNCTIONS

Input Side

Input Tray

Used to guide items into the machine. Leading edge of document should slide underneath paddle for best results. Tray has extendable "arm" for use when loading long items. Arm is shown closed.

Top Cover

Opens up for cartridge replacement (see label when open).

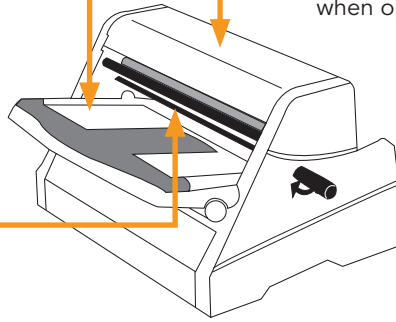

Paddle

Used to provide back tension on delicate or long items to ensure wrinkle-free results.

Output Side

Crank Handle

Used to advance cartridge supplies and item when rotated clockwise.

Cut Blade

Used to cut items after they have exited machine. To use, press downward and slide to the left or right.

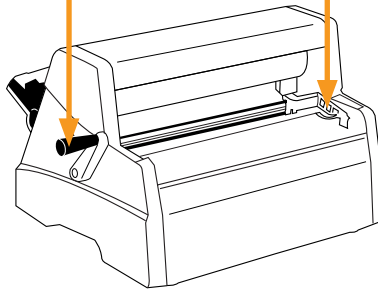

Top Cover

Shown open for cartridge removal/installation

Replaceable Supply Cartridge

(see various types of Refill Cartridge section)

Input Tray

Shown removed for cartridge removal/installation

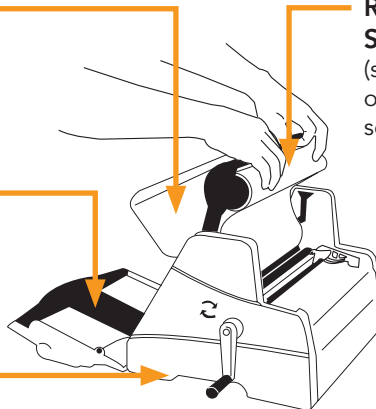

Lifting Points

Areas located on both sides of the machine for lifting.

ASSEMBLY INSTRUCTIONS

Remove the XM1255, crank handle assembly and hex wrench from the packaging.

1. Place the Crank Handle assembly onto the D-shaped roller shaft with the set screw facing upward.
2. Move the handle forward on the D-shaped shaft until it stops.
3. Use the Hex wrench to secure the set screw.

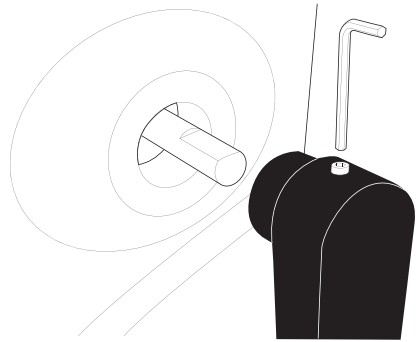

LOADING CARTRIDGES

Step 1:

Slide input tray out of machine by pressing tabs on each side.

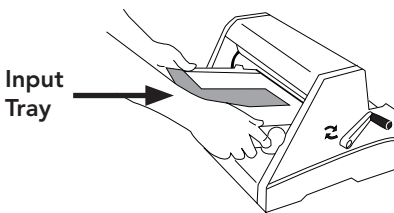

Step 2:

With top cover open, lift out used cartridge completely. Replace cartridge with new one.

Make sure label is up and viewable from top input side of machine.

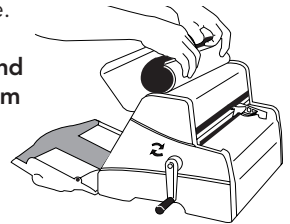

Step 3:

From the input side, insert starter card into machine between the substrates to start material through the rollers. Turn the handle of the machine in a clockwise direction. This will advance the material.

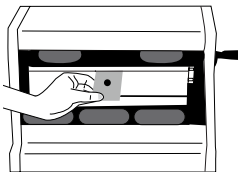

Step 4:

Advance the film through the machine until the film is aligned and wrinkle free. This may take 6-10 inches. Reinsert the tray. Be sure it "snaps" into place.

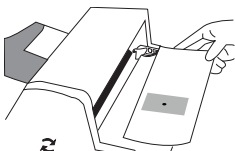
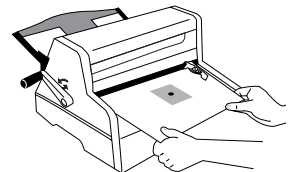

Step 5:

Press down the orange blade holder and slide it in either direction to trim excess film.

BASIC OPERATION

Step 1:

Before inserting your document, turn crank handle clockwise one revolution to ensure film is wrinkle-free. Insert and align document on feed tray. Extend the document underneath the paddle on the feed tray and completely into the cartridge opening until it touches the film/adhesive.

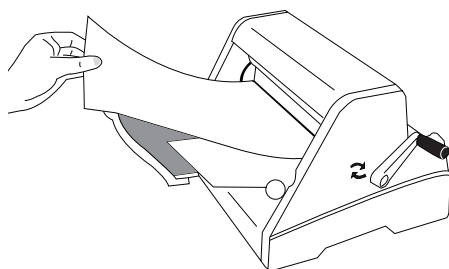

Step 2:

Gently guide the document forward while turning the crank handle clockwise. **TIP:** To save a later trimming operation, trim off any excess material on the leading edge of the output (with cut blade) before advancing completely through the dispenser.

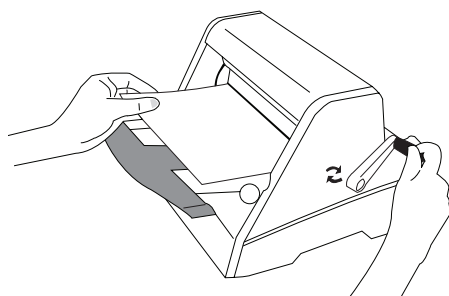

Step 3:

Trim to desired length using the cut blade at the roller exit. Apply downward pressure on the orange blade holder and slide to the left or right. **TIP:** To save a later trimming operation, turn the crank to advanced the document until the leading edge is aligned with the upper blade bar supporting the cut blade. Trim excess material from the leading edge of the document. Continued to crank document through machine and trim when finished.

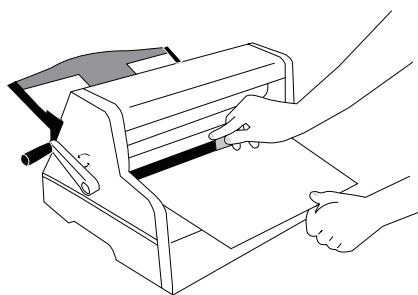

How to remove document from adhesive

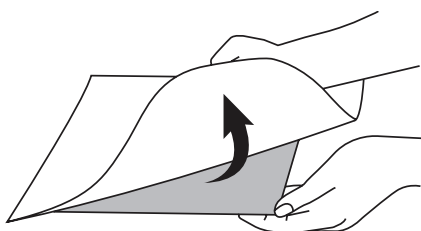

Proper Technique

- Remove the protective clear mask layer and discard.
- Always remove the liner from the media as shown.

AVAILABLE SUPPLY ROLL

Product Supply Description

- **Permanent High-Tack Adhesive:** Extremely aggressive adhesive instantly creates a permanent bond on most surfaces. Sets instantly and will not peel. Acid-Free.
- **Permanent Standard Adhesive:** Moderately aggressive adhesive creates a permanent bond on most surfaces. Can be touched to surface, peeled back quickly, and replaced. Acid-Free.
- **Repositionable Adhesive:** Allows items to be repositioned over and over. Easy removal from glass, walls, paper, and most other surfaces. Acid-Free.
- **Standard Use Laminate:** High gloss film suitable for use on a variety of substrates. Superior adhesion. Compatible with most media. Acid-Free.
- **Combination-Laminate/Adhesive:** One of the laminate products described on the top surface and one of the Acid-Free adhesives described on the bottom surface. Acid-Free.

Part Number	Product Description	Material Length	Material Width	Laminate & Adhesive Combination Thickness (per side)	Mounting Adhesive Thickness	Adhesive PH	Mounting Adhesive Strength: 1-10 (10 High)	PAT Approved	
Adhesive Application Cartridges									
● AT1251-100	Permanent High-Tack	100' (30.5m)	12" (30.5cm)	N/A	0.6mil (15.2mic)	Acid-Free	10	Yes	
● AT1255-100	Permanent Standard	100' (30.5m)	12" (30.5cm)	N/A	0.6mil (15.2mic)	Acid-Free	8	Yes	
● AT1256-100	Repositionable	100' (30.5m)	12" (30.5cm)	N/A	1.1mil (27.9mic)	Acid-Free	3	Yes	
Lamination Cartridges									
● DL1251-100	2-Sided Standard Use Laminate	150' (45.7m)	12" (30.5cm)	2.7mil (67.5mic)	N/A	Acid-Free	N/A	Yes	
Combination One Side Laminate / One Side Adhesive Application Cartridges									
● LAT1251-100	Standard Use Laminate/ High-Tack Adhesive	100' (30.5m)	12" (30.5cm)	2.7mil (67.5mic)	0.6mil (15.2mic)	Acid-Free	10	Yes	
● LAT1256-100	Standard Use Laminate/ Repositionable Adhesive	100' (30.5m)	12" (30.5cm)	2.7mil (67.5mic)	1.1mil (27.9mic)	Acid-Free	3	Yes	

Cutter

2342.01	Replaceable Cutter Bar and Blade Assembly
1343.01	Replacement Tray

Product Specifications

Footprint	10.5" x 13" x 15" (26.7cm x 33cm x 38.1cm)
Weight/Packed Weight	14.75lbs (6.6kg) / 18.25lbs (8.2kg)
Document Thickness (max.)	0.125" (3.2mm)
Finished Document Width (max.)	11.75" (29.8cm)
Power Requirements	None
Cutter	Removable, replaceable cutter

TROUBLESHOOTING

Symptom	Cause	Solution
Cut blade does not cut smoothly.	Adhesive build up on cutting mechanism.	Use caution and follow cleaning procedure listed below.
Film does not exit dispenser between upper and lower blade bars.	Material is curled or adhesive has been transferred to the nip roller causing the film to stick.	Remove material and clean adhesive from rollers if necessary. Reposition material between blade bars.
Film wrinkles don't go away as crank is turned clockwise.	Adhesive build-up on rollers.	Apply adhesive cleaner to remove build-up on rollers.
Material will not advance when crank handle is turned.	Material is not positioned between rollers or laminate is adhered to input tray.	Reinstall cartridge. Slide input tray outward to release film and turn handle to assure laminate is wrinkle-free. Slide input tray back into machine.
Document wrinkles or exits machine crooked.	Adhesive build-up on front edge of input tray.	Remove adhesive from front edge of input tray.
Document peels from mounting surface at opposite corners.	Improper peel technique introduces curl in document.	Use the proper peel technique of peeling the liner from the document as shown on the previous page.

How to Change & Maintain your Cut System

Using the finger tab of the cut bar spring, pull in and carefully remove the cut bar assembly from the machine (be cautious of exposed blade). Using caution, apply adhesive cleaner to all surfaces of bar blade. Once adhesive build-up is removed, return the cut bar assembly to the machine, guiding the location pins into the holes in the side plates.

Warranty Information

Xyron, Inc. warrants that the XM1255 is free from defects in material and workmanship for a period of one (1) year from the date of purchase. Xyron, Inc. will repair or replace a defective product or part without charge, with proof of purchase. If the product is damaged by neglect or misuse, the warranty is null and void.

To register your product online, please go to www.xyronpro.com and click on the product registration tab.

*If you purchased this product outside the United States Xyron will warrant this product in accordance with the purchasing country's laws.**

**Excludes Australia

Customer Service

We want you to be happy with your purchase of a Xyron product. If for any reason you have a problem or a question, please contact Xyron Customer Service toll-free at 1-800-793-3523 or 1-480-443-9419 for help. You can also e-mail us at: customerservice@xyron.com

For customer service outside of the U.S.

Australia: 61 2 8899 8500; australiacustomers@esselte.com

New Zealand: 64 9 272 1600; nzcustomers@esselte.com

Europe: 44 845 67801801

Asia: 813 5719 6450

1445.03_RevD

©2011 Xyron, Inc.
8465 N. 90th St. Suite 6
Pima Center
Socttsdale, AZ 85258

 **XYRON**®

An  **Esselte**® Company

Visit www.xyronpro.com for more information