

Lassco Wizer

BINDERY, FINISHING, & MORE

LASSCOJOG® PAPER JOGGERS
CORNEROUNDER® CORNER CUTTERS
SPINNIT® PAPER DRILLS
PADDING EQUIPMENT
STAPLERS AND STAPLES
NUMBERING MACHINES
PERFORATING AND SCORING MACHINES
PRESS EQUIPMENT

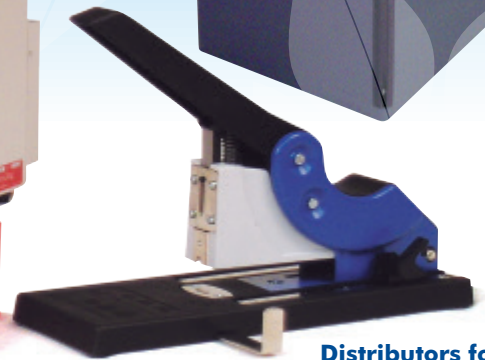
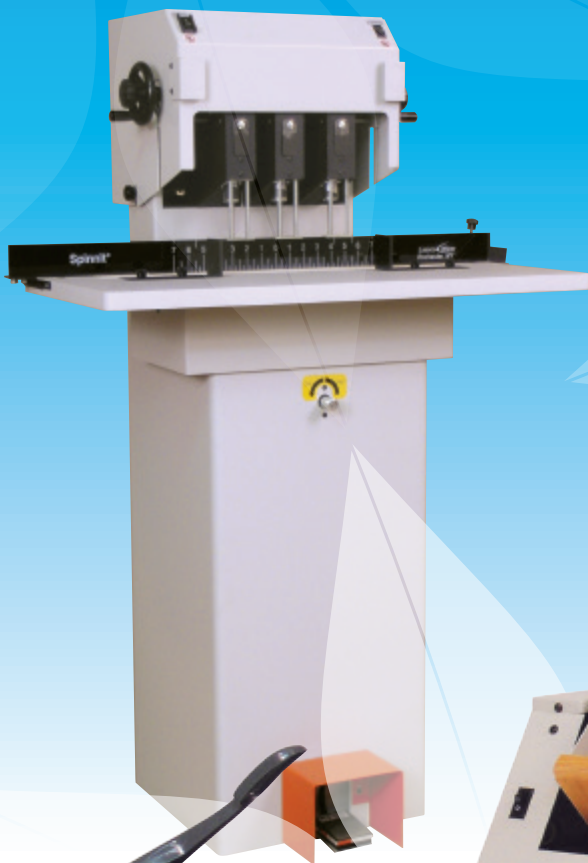

Distributors for:





TABLE OF CONTENTS

PAPER JOGGERS..... PAGE 02
CORNER CUTTERS & ACCESSORIES.....PAGE 03 - PAGE 06
PAPER DRILLS..... PAGE 07 - PAGE 10
PAPER DRILL ACCESSORIES..... PAGE 11
PADDING EQUIPMENT & SUPPLIES..... PAGE 12
STAPLERS AND ACCESSORIES..... PAGE 13 - PAGE 14
NUMBERING, PERFORATING, AND SCORING..... PAGE 15
COUNT NUMBER, PERF, SCORE, & CREASE..... PAGE 16
PRESS EQUIPMENT AND ACCESSORIES.....PAGE 17
INCOMING FREIGHT DAMAGE.....PAGE 18
LASSCO WIZER WARRANTY..... BACK COVER
RETURN POLICY..... BACK COVER

LJ-2 Table Top Jogger



- Perfect for quick print and mail rooms
- Jogs a full ream of standard copy paper
- Jogs 1/2 ream of 11" x 17" paper
- Ideal for checks and envelopes

Specifications

- Table size: 4" x 7" x 12-1/2"
- Motor: 115 Volt, 60 Hz, 2.2 amp, 1550 RPM
- Actual weight: 24 lbs
- Shipping weight: 35 lbs
- Ships via: UPS

LJ-4 Table Top Jogger

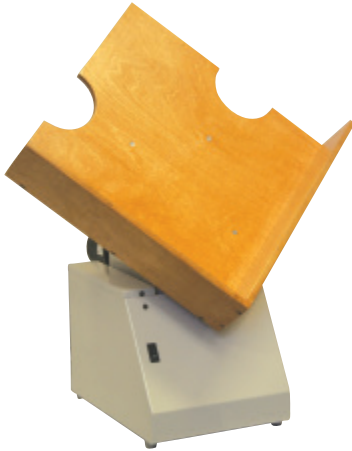

- Large table allows for perfect alignment of all forms of paper products
- Jogs a full ream of up to 11" x 17" paper

Specifications

- Table size: 17" x 17" x 4-1/4"
- Motor: 115 Volt, 60 Hz, 2.2 amp, 1550 RPM
- Actual weight: 28 lbs
- Shipping weight (two cartons): 39 lbs
- Ships via: UPS

LJ-6 Multi-Bin Jogger



- Four bins for faster sorting and collating of paper, envelopes, checks, and other materials
- Perfect for banks and mail rooms

Specifications

- Table size: 18-1/2" x 10" x 4" with four bins 4" x 4" x 9-1/2" ea.
- Motor: 115 Volt, 60 Hz, 2.2 amp, 1550 RPM
- Actual weight: 30 lbs
- Shipping weight (two cartons): 37 lbs
- Ships via: UPS

LJ-8 Flat Top Jogger



- Large table allows for easy handling of bulky materials
- Hand-held jogging designed for glossy stacks, newspapers, and magazines

Specifications

- Table size: 20" x 14"
- Motor: 115 Volt, 60 Hz, 2.2 amp, 1550 RPM
- Actual weight: 26 lbs
- Shipping weight: 49 lbs
- Ships via: UPS

Cornerounder® CORNER CUTTERS

CR-50XP Pneumatic Corner Cutter



- Designed to cut paper and plastic products
- Pneumatic operation with foot pedal activation
- Powered by your in-house air or with our select compact compressor (compressor sold separately)
- Can be operated up to 60 strokes per minute

Specifications

- Table size: 17" x 17"
- Actual weight: 73 lbs
- Shipping weight: 134 lbs
- Ships via: LTL Truck
- Accepts Standard, Special, and Large size Cornerounder® cutting units (one Standard size cutting unit included)

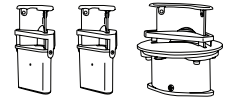

CR-50P Electric Corner Cutter



- Designed to cut paper and plastic products
- Electric operation with foot pedal activation for fast and effortless cutting
- Can be operated up to 30 strokes per minute

Specifications

- Table size: 17" x 17"
- Actual weight: 70 lbs
- Shipping weight: 113 lbs
- Ships via: LTL Truck
- Accepts Standard, Special, and Large size Cornerounder® cutting units (one Standard size cutting unit included)



CR-50 Manual Corner Cutter



- Designed to cut paper and plastic products
- Manual operation with conveniently located foot pedal for fast and economical corner cutting

Specifications

- Table size: 15" x 15"
- Actual weight: 40 lbs
- Shipping weight: 84 lbs
- Ships via: UPS
- Accepts Standard, Special, and Large size Cornerounder® cutting units (one Standard size cutting unit included)

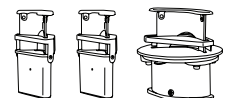

Comparison Chart

	CR-50XP	CR-50P	CR-50
Strokes per minute	60	30	N/A
Power requirements	80 PSI	115 Volt 60 Hz	Manual
Table dimensions	17" x 17"	17" x 17"	15" x 15"
Actual weight	73 lbs	90 lbs	44 lbs
Shipping weight	134 lbs	113 lbs	84 lbs (dimensional)
Shipping dimensions	26" x 24" x 42"	20" x 20" x 42"	18" x 18" x 43"

CR-20 Corner Cutter



- Designed to cut paper and soft plastic products
- Handles up to a 1/2" of stock per cut
- Shear action cutting
- Its 5" x 10-1/2" size makes it easy for use all around any office or factory
- Unbreakable plastic top-plate

Specifications

- Table size: 5" x 10-1/2"
- Actual weight: 3 lbs
- Shipping weight: 4 lbs
- Ships via: UPS

- Accepts Standard and Special size Cornerrounder® cutting units (one Standard size cutting unit included)

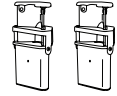

CR-50B Corner Cutter



- Designed to cut paper and plastic products
- Handles up to a 1/2" of stock per cut
- Shear action cutting
- Table size of 9" x 18" to handle large products
- Heavy-duty wooden top-plate

Specifications

- Table size: 9" x 18"
- Actual weight: 9 lbs
- Shipping weight: 11 lbs
- Ships via: UPS

- Accepts Standard, Special, and Large size Cornerrounder® cutting units (one Standard size cutting unit included)

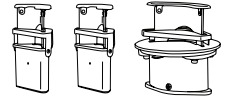

Cornerrounder® Cutting Units

Standard Size



- Up to 1/2" capacity
- Hardened blades for long lasting use

Size	Item ID
1/8"	CU18
1/4"	CU14
3/8"	CU38
1/2"	CU12

Special Size



- Up to 1/2" capacity
- Hardened blades for long lasting use

Size	Item ID
1/16"	CU116
3/32"	CU332
5/32"	CU532
3/16"	CU316
5/16"	CU516
5/8"	CU58

Large Size



- Up to 1/8" capacity
- Hardened blades for long lasting use

Size	Item ID
3/4"	CU34
1"	CU1
1-1/2"	CU112

Radii Chart

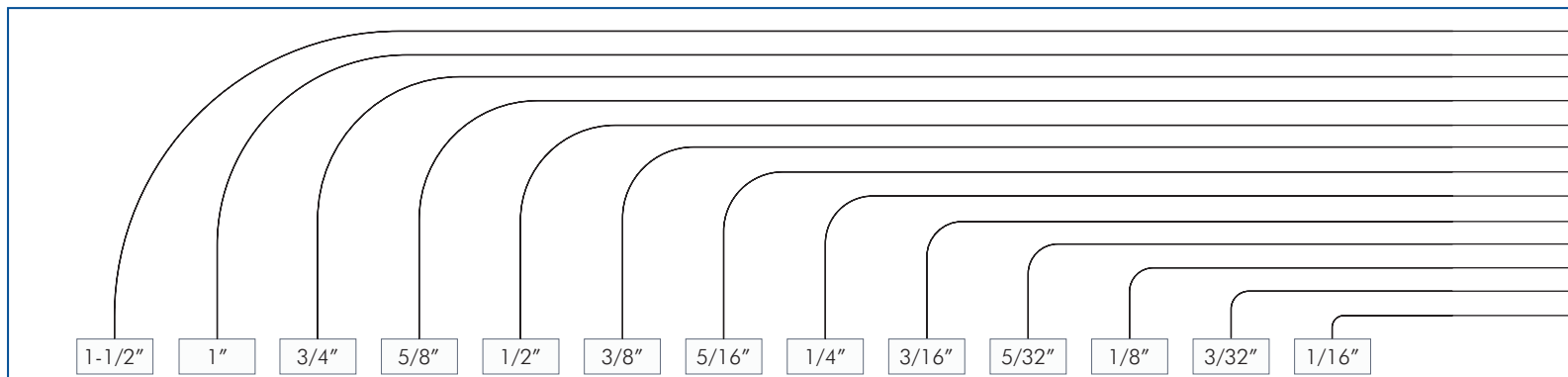

chart is to scale

CR-55 Manual 2" Corner Cutter **NEW**





- 2" cutting capacity
- Ideal for high volume cutting
- Manual foot operation

Specifications

- Table size: 20" x 20"
- Actual weight: 79 lbs
- Shipping weight: 138 lbs
- Ships via: LTL Truck

Specify Radii Set

Set One

- 3/8"  1/4" Die • W177-C
-  1/4" Radii Blade • CR55-14
-  3/8" Radii Blade • CR55-38

Set Two

- 1/2"  1/8" Die • W177-F
-  1/8" Radii Blade • CR55-18
-  1/2" Radii Blade • CR55-12

Note: The CR-55 does not use the Cornerounder® Cutting Units.

CR-177 1" Corner Cutter

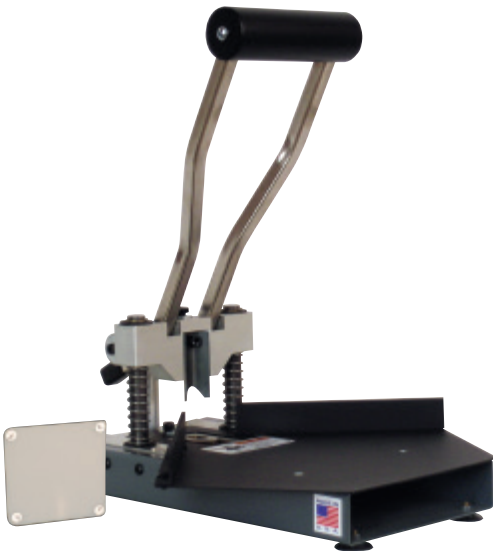

- Designed to handle paper and plastic products
- Features a long handle with a 5" wide grip for added leverage and comfort
- Cuts up to a 1" stack of product

Specifications

- Table size: 15" x 15"
- Actual weight: 8 lbs
- Shipping weight: 16 lbs
- Ships via: UPS

• A total of four radii sizes are available for this machine and are comprised of two sets each containing two different sizes. Blades and Dies can be purchased individually but require a matching set for operation. The sets are as follows:

Specify Radii Set

Set One

- 3/8"  1/4" Die • W177-C
-  1/4" Radii Blade • CR177-14
-  3/8" Radii Blade • CR177-38

Set Two

- 1/2"  1/8" Die • W177-F
-  1/8" Radii Blade • CR177-18
-  1/2" Radii Blade • CR177-12

Note: The CR-177 does not use the Cornerounder® Cutting Units.

CR-60 Corner Cutter



- Designed especially for the sign industry
- Features a one ton press capacity
- Interchangeable tables, which allow for quick changes of radii
- Shear capacity of up to .080 half hard aluminum

Specifications

- Table size: 9" x 9"
 - Actual weight: 40 lbs
 - Shipping weight: 45 lbs
 - Ships via: UPS
- Includes your choice of one out of the four available size Cornerounder® Table Assemblies with purchase (see below)

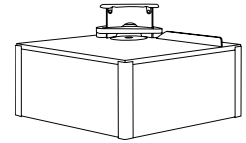

Note: The CR-60 does not use the Cornerounder® Cutting Units.

Cornerounder® Table Assemblies for the CR-60



- For use with the CR-60 corner cutter
- Replacement outer knives are available for all sizes to replace worn out blades on Table Assemblies

Size	Table Assembly ID	Replacement Outer Knives ID
1/2"	60-12TA	60-120
3/4"	60-34TA	CU340
1"	60-1TA	CU10
1-1/2"	60-112TA	CU1120

Specifications

- Actual weight: 6 lbs
- Shipping weight: 6 lbs
- Ships via: UPS

Cornerounder® Accessories CR-PB 1" Push Block

NEW



- Right angle 90° block for use with up to 1" stacks
- Designed to assist with the corner cutting of smaller products like business cards
- Prevents the product from slipping or being pushed out while cutting
- Helps to maintain a properly squared stack

Specifications

- Shipping weight: 1 lbs
- Ships via: UPS

CR55-PB 2" Push Block

NEW



- Right angle 90° block for use with up to 2" stacks
- Designed to assist with the corner cutting of smaller products like business cards
- Prevents the product from slipping or being pushed out while cutting
- Helps to maintain a properly squared stack

Specifications

- Shipping weight: 1 lbs
- Ships via: UPS

CR-AG Alignment Guide

NEW



- Guide to help align the blade and dies when setting up the CR-55 or CR-177

Specifications

- Shipping weight: 1 lbs
- Ships via: UPS

FMMH-3.1 Hydraulic Lift Paper Drill **NEW**



- Three spindles with a 2-1/2" drilling capacity
- Powerful hydraulic lift with foot pedal activation
- Sturdy adjustable back-gauge
- Easy to adjust moveable head design
- Adjustable hydraulic lift speed
- Built for ease in operation and maximum production performance

FMMH-2.1 Hydraulic Lift Paper Drill

- Identical to the FMMH-3.1 except with two moveable heads

FMMH-2.1C Hydraulic Lift Paper Drill

- Similar to the FMMH-3.1 but designed specifically for Casino's to cancel decks of cards.
- Has a fixed drawer system which allows easy drilling of six decks of cards at one time.

Specifications

- | | |
|---------------------------------|--|
| • Table size: 15" x 32" | • Spindle Motor: 3/4 HP, 115 Volts |
| • Base footprint: 18" x 22" | • Hydraulic Motor: 1/2 HP, 115 Volts |
| • Table height: 36" | • Actual weight: 345 lbs |
| • Overall height: 54" | • Shipping weight: 460 lbs |
| • Overall width: 32" | • Shipping dimensions: 48" x 40" x 63" |
| • Overall depth: 31" | • Ships via: LTL Truck |
| • Max drilling capacity: 2-1/2" | |

Accessories

- Hydrol HL hydraulic oil (1.5 Gallons)
- Drill strip
- Style A 2.5" hollow drill bits

Item ID

- FMH-2030
- FM4-4001
- Various

FMMH-3 Hydraulic Lift Paper Drill **NEW**

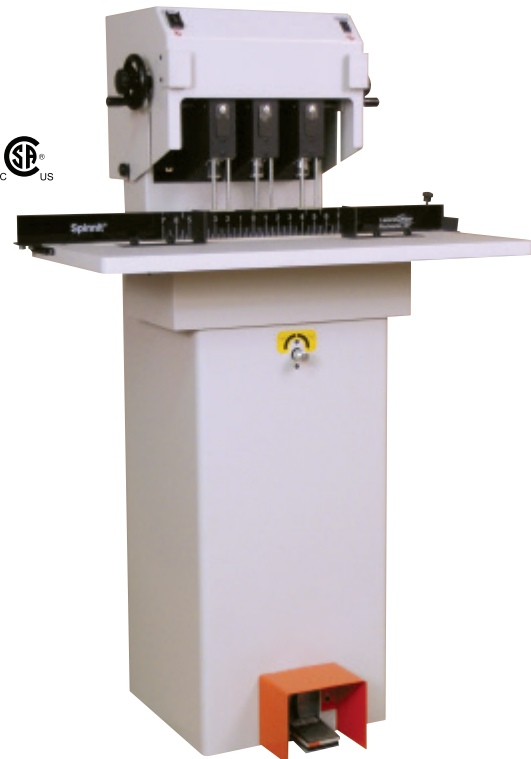

- Three spindles with a 2" drilling capacity
- Powerful hydraulic lift with foot pedal activation
- Sturdy adjustable back-gauge
- Easy to adjust moveable head design
- Adjustable hydraulic lift speed
- Built for ease in operation and maximum production performance

FMMH-2 Hydraulic Lift Paper Drill

- Identical to the FMMH-3 except with two moveable heads

Specifications

- | | |
|-----------------------------|--|
| • Table size: 15" x 32" | • Spindle Motor: 3/4 HP, 115 Volts |
| • Base footprint: 15" x 15" | • Hydraulic Motor: 1/2 HP, 115 Volts |
| • Table height: 35-1/2" | • Actual weight: 220 lbs |
| • Overall height: 52" | • Shipping weight: 335 lbs |
| • Overall width: 32" | • Shipping dimensions: 48" x 40" x 60" |
| • Overall depth: 26" | • Ships via: LTL Truck |
| • Max drilling capacity: 2" | |

Accessories

- Hydrol HL hydraulic oil (1.5 Gallons)
- Drill strip
- Style A 2" hollow drill bits

Item ID

- FMH-2030
- FM4-4001
- Various

All floor model drills include...

- MS-1 drill sharpener
- Spin-Eze drill bit lubricant
- Set of 5/16" drill bits
- Sharpening stone
- Chip clearer

FMM-3 Manual Lift Paper Drill

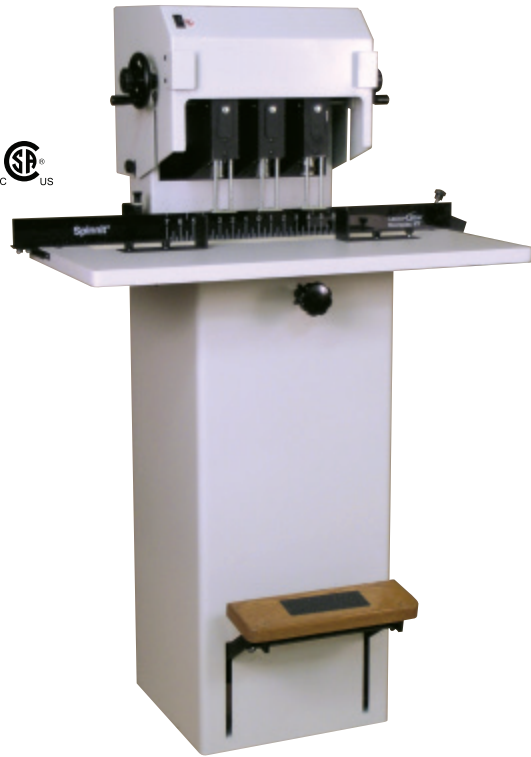

- The lowest priced 3 spindle drill on the market
- 2" drilling capacity
- Easy to adjust moveable head design
- Rugged mechanical lift table
- Built for ease in operation and maximum production performance

FMMS-3 Manual Lift Paper Drill

- Identical to the FMM-3 except with stationary heads set for drilling three holes, 4-1/4" center-to-center.

Specifications

- Table size: 15" x 32"
- Base footprint: 15" x 15"
- Table height: 35-1/2"
- Overall height: 52"
- Overall width: 32"
- Overall depth: 26"
- Max drilling capacity: 2"
- Motor: 3/4 HP, 115 Volts
- Shipping dimensions: 48" x 40" x 60"
- Ships via: LTL Truck

FMM-3

- Actual weight: 195 lbs
- Shipping weight: 292 lbs

FMMS-3

- Actual weight: 178 lbs
- Shipping weight: 275 lbs

Accessories

- Drill strip
- Style A 2" hollow drill bits

Item ID

FM4-4001
Various

FMM-2 Manual Lift Paper Drill

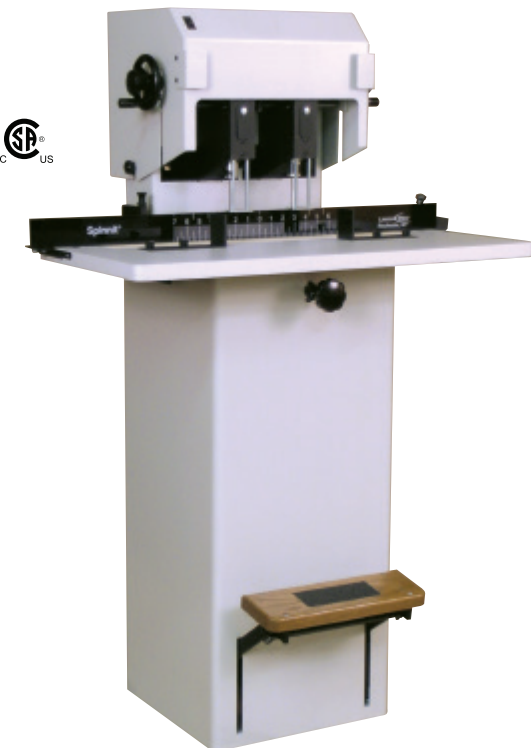

- 2" capacity two hole drilling
- Moveable heads for drilling versatility
- Manual lift with a foot pedal activation for reduced cost

Specifications

- Table size: 15" x 32"
- Base footprint: 15" x 15"
- Table height: 35-1/2"
- Overall height: 52"
- Overall width: 32"
- Overall depth: 26"
- Maximum drilling capacity: 2"
- Motor: 3/4 HP, 115 Volts
- Actual weight: 187 lbs
- Shipping weight: 284 lbs
- Shipping dimensions: 48" x 40" x 60"
- Ships via: LTL Truck

Accessories

- Drill strip
- Style A 2" hollow drill bits

Item ID

FM4-4001
Various

FM-2 Manual Lift Paper Drill **NEW**



- E-Z Glide table system uses pattern bars which allows for quick movement from hole to hole for multi-hole drilling, operated with a release lever positioned on each side of the table to provide either right or left handed operation
- Single spindle drill
- 2" drilling capacity
- Low maintenance and efficient operation
- Lowest cost floor model drill on the market

Specifications

- Table size: 15" x 32"
- Base footprint: 15" x 15"
- Table height: 35-1/2"
- Overall height: 54"
- Overall width: 32"
- Overall depth: 26"
- Max drilling capacity: 2"
- Motor: 1/4 HP, 115 Volts
- Actual weight: 150 lbs
- Shipping weight: 260 lbs
- Shipping dimensions: 48" x 40" x 60"
- Ships via: LTL Truck

- Included with the machine are four patterns for multi-hole drilling. The sizes are as follows:

- 3 holes, 2-3/4" apart center to center
- 3 holes, 3-1/2" apart center to center
- 2 holes, 2-3/4" apart center to center
- 3 holes, 4-1/4" apart center to center

Accessories

- Drill strip
- Style A 2" hollow drill bits

Item ID

EBM2-1034
Various

Drill Bit Diameter Chart

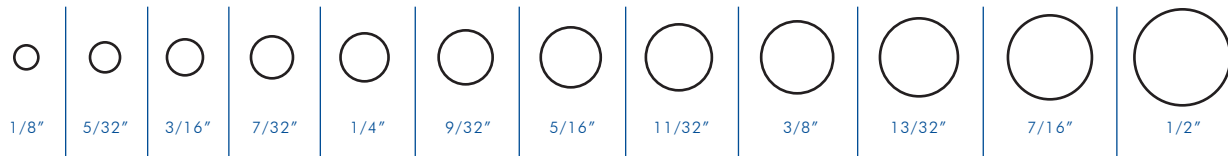

Paper Drill Comparison Chart

	FMMH-3.1	FMMH-2.1	FMMH-3	FMMH-2	FMM-3
Number of spindles	3	2	3	2	3
Distance between spindles	2" - 5"	2" - 5"	2" - 5"	2" - 5"	2" - 5"
Horsepower	3/4	3/4	3/4	3/4	3/4
Voltage	115	115	115	115	115
Table size	15" x 32"	15" x 32"	15" x 32"	15" x 32"	15" x 32"
Max throat depth*	2"	2"	2"	2"	2"
Table travel	N/A	N/A	N/A	N/A	14"
Table height	36"	36"	35-1/2"	35-1/2"	35-1/2"
Base footprint	18" x 22"	18" x 22"	15" x 15"	15" x 15"	15" x 15"
Overall height	54"	54"	52"	52"	52"
Actual Weight	345 lbs	342 lbs	220 lbs	218 lbs	195 lbs
Shipping weight	460 lbs	460 lbs	335 lbs	335 lbs	292 lbs
Shipping dimensions	48" x 40" x 63"	48" x 40" x 63"	48" x 40" x 60"	48" x 40" x 60"	48" x 40" x 60"

All table-top model drills include...

- Spin-Eze drill bit lubricant
- 5/16" drill bit
- Sharpening stone
- Chip clearer

EBM-2.1 Table-Top Paper Drill



- E-Z Glide table system uses pattern bars which allows for quick movement from hole to hole for multi-hole drilling, operated with a release lever positioned on each side of the table to provide either right or left handed operation
- Adjustable side stops allow you to trap your product to prevent misalignment
- Easy to set up and use with minimal installation necessary

Specifications

- Table size: 18" x 12"
- Base footprint: 12" x 13-1/2"
- Table height: 3-1/2"
- Max drilling capacity: 2"
- Motor: 1/4 HP, 115 Volts
- Actual weight: 66 lbs
- Shipping weight: 104 lbs
- Shipping dimensions: 34" x 25" x 23"
- Ships Via: LTL Truck

- Included with the machine are four patterns for multi-hole drilling. The sizes are as follows:

- 3 holes, 2-3/4" apart center to center
- 3 holes, 3-1/2" apart center to center
- 2 holes, 2-3/4" apart center to center
- 3 holes, 4-1/4" apart center to center

Accessories

- Drill strip
- Style A 2" hollow drill bits

Item ID

EBM2-1034
Various

EBM-S Table-Top Paper Drill



- The most economical 2" capacity table-top drill on the market
- Stationary table with an adjustable back-gauge slide guide system
- Product moves across the table for easy multi-hole drilling
- Ideal for small print operations

Specifications

- Table size: 18" x 12"
- Base footprint: 12" x 13-1/2"
- Table height: 3-1/2"
- Max drilling capacity: 2"
- Motor: 1/4 HP, 115 Volts
- Actual weight: 62 lbs
- Shipping weight: 104 lbs
- Shipping dimensions: 34" x 25" x 23"
- Ships Via: UPS

Accessories

- Drill block
- Style A 2" hollow drill bits

Item ID

EBM-10
Various

FMMS - 3	FMM - 2	FM - 2	EBM - 2.1	EBM - S
3	2	1	1	1
4-1/4"	2-3/8" - 10"	N/A	N/A	N/A
3/4	3/4	1/4	1/4	1/4
115	115	115	115	115
15" x 32"	15" x 32"	12" x 24"	18" x 12"	18" x 12"
2"	2"	1-3/4"	1-3/8"	2-1/8"
14"	14"	14"	14"	N/A
35-1/2"	35-1/2"	35-1/2"	3-1/2"	3-1/2"
15" x 15"	15" x 15"	15" x 15"	12" x 13-1/2"	12" x 13-1/2"
52"	52"	54"	26"	26"
178 lbs	187 lbs	150 lbs	66 lbs	62 lbs
275 lbs	284 lbs	260 lbs	101 lbs	101 lbs
48" x 40" x 60"	48" x 40" x 60"	48" x 40" x 60"	35" x 25" x 23"	35" x 25" x 23"

MS-1 Drill Bit Sharpener



- For use with Style A and L hollow drill bits
- Precision sharpener with a self-seating, lathe type construction on a heavy-duty base
- Constructed with a solid carbide cutting head for a long sharpening life

Specifications

- Actual weight: 2 lbs
- Shipping weight: 2 lbs
- Ships via: UPS

Drill Blocks



- For Spinnit® and Challenge drill machines
- Made of solid hard wood
- Packaged by the dozen

Size	Brand(s)	Item ID
1-1/2" dia x 3/4" thick	Spinnit®/ Challenge	EBM-10
3" dia x 3/4" thick	Challenge	W170-B

MS-3 Hand-Held Drill Bit Sharpener



- Easy to use hand-held sharpener
- Constructed with a solid carbide cutting head

Specifications

- Actual weight: 1 lb
- Shipping weight: 1 lb
- Ships via: UPS

Drill Strips

Size	For Use With...	Item ID	Unit
16" x 2" x 1/2"	Spinnit® EBM-2.1, FM-2	EBM2-1034	Each
25" x 2" x 1/2"	Spinnit® floor model machines (except FM-2)	FM4-4001	Each

Hollow Drill Bits

Style A 2"



- Lassco Wizer Spinnit®
- Challenge

Size/Description	Item ID
1/8" Premium.....	PD18P-2
1/8" Premium Coated..	PD18PT-2
5/32" Premium.....	PD532P-2
3/16" Standard.....	PD316-2
3/16" Standard Coated..	PD316T-2
3/16" Premium.....	PD316P-2
3/16" Premium Coated..	PD316PT-2
7/32" Premium.....	PD732P-2
1/4" Standard.....	PD14-2
1/4" Standard Coated..	PD14T-2
1/4" Premium.....	PD14P-2
1/4" Premium Coated..	PD14PT-2
9/32" Premium.....	PD932P-2
5/16" Standard.....	PD516-2
5/16" Standard Coated..	PD516T-2
5/16" Premium.....	PD516P-2
5/16" Premium Coated..	PD516PT-2
11/32" Premium.....	PD1132P-2
3/8" Standard.....	PD38-2
3/8" Standard Coated..	PD38T-2
3/8" Premium.....	PD38P-2
3/8" Premium Coated..	PD38PT-2
13/32" Premium.....	PD1332P-2
7/16" Premium.....	PD716P-2
1/2" Standard.....	PD12-2
1/2" Standard Coated..	PD12T-2
1/2" Premium.....	PD12P-2

Style A 2-1/2"



- Lassco Wizer Spinnit®
- Challenge

Size/Description	Item ID
1/4" Standard.....	PD14-2.5
1/4" Standard Coated..	PD14T-2.5
1/4" Premium.....	PD14P-2.5
5/16" Standard.....	PD516-2.5
5/16" Standard Coated..	PD516T-2.5
5/16" Premium.....	PD516P-2.5
5/16" Premium Coated..	PD516PT-2.5
3/8" Premium.....	PD38P-2.5

Style H 2-1/2"



- Lassco Wizer Spinnit®
- Hang

Size/Description	Item ID
1/4" Premium.....	PD14P-H
5/16" Premium.....	PD516P-H
5/16" Premium Coated..	PD516PT-H
3/8" Premium.....	PD38P-H

Style L 1"



- Lassco Wizer Spinnit®

Size/Description	Item ID
1/8" Premium.....	PD18P1
3/16" Standard.....	PD316-1
1/4" Standard.....	PD14-1
5/16" Standard.....	PD516-1
3/8" Standard.....	PD38-1
1/2" Premium.....	PD12P-1

CC-2 Chip Clearer



- Removes chips from all styles of hollow drill bits
- Long lasting and durable

Spin-Eze Drill Bit Lubricant



- Tetra lube oil based lubricant
- 1 oz bottle with application brush attached

Drill-Ease Drill Bit Lubricant



- Wax based lubricant
- Reduces friction and heat during drilling

Unit	Item ID
3 pack	W171-1
12 pack	W171-2
24 pack	W171-3

EBM-32 Chuck Release Key



- For use with Spinnit® paper drills using style A and L drill bits
- High quality steel construction

W175 Ultra II™ Padding Press



- Adjustable with up to 10,000 sheet capacity
- Pads up to 18" wide, 18" high
- 360 degree swivel base allows high production without lifting the load
- Heavy-duty cast iron clamps
- Requires minimal counter space
- Rugged high quality hardwood and steel construction
- Easy-to-use... simply stack the paper and clamp down, swivel the stack to face you, remove the back board and apply padding adhesive.

Specifications

- Actual weight: 35 lbs
- Shipping weight: 40 lbs
- Ships via: UPS

W176 Padding Compound



- White
- Water soluble so material can be easily cleaned with plain water
- Quick drying and long lasting

Specifications

- Volume: 1 quart
- Shipping weight: 3 lbs
- Ships via: UPS

W178 Padding Brush



- 2" brush width
- Durable wooden handle

Pad Counters



- Constructed with a solid wood handle and chrome plated spade for durability
- Available in 3 sizes

Size	Item ID
Adjustable to 2"	W172
Adjustable to 4"	W172-B
Adjustable to 5"	W172-C

W174 Pad Separating Knife



- Separates pads smoothly and easily
- Carbon steel blade with solid wood handle

W179 Plastic Pile Separator

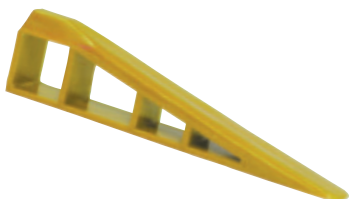

- Longer taper than wooden wedges
- Permits closer adjustment
- Prevents messes, dripping, and folding under

Size

- Length: 6"
- Width: 3/4"
- Height: 1-3/8"

Rapid 106 Electric Stapler



- Flat to saddle stapling in seconds
- Electric foot pedal activation for saddle stapling
- Dual adjustable touch trips for flat stapling
- Easy bench mount
- Binds up to 40 sheets flat or 20 sheets saddle
- Push button loading
- Multiple Rapid 106 staplers can be combined using the group stapling kit shown below for simultaneous stapling

Specifications

- Actual weight: 11 lbs
- Shipping weight: 14 lbs
- Ships via: UPS

WT06-K Group Stapling Kit

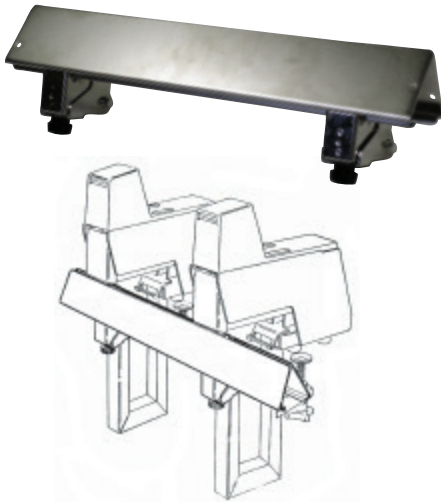

- Designed for the Rapid 106 and allows for multi-stapling
- Operate two or more Rapid 106 staplers side by side with one foot switch
- Attached by optic cable
- Runner only accomodates saddle stapling

Includes...

- Saddle runner with two brackets
- Optic cable
- Two small anvils

Specifications

- Minimum distance between staples: 2-1/2"
- Maximum distance between staples: 15"
- Actual weight: 3 lbs
- Shipping weight: 4 lbs
- Ships via: UPS

Replacement Stapling Heads



Stapler(s)

Rapid 101
 Rapid 106
 MBM Sprint Booklet Maker / O & M System 60
 (does not have trigger for "out of staples" indicator)

Item ID

W101-301
 W106-B
 W110

Staples (For Rapid 101 and 106)



- For use in the Rapid 101 and 106 staplers
- Chisel point for the best performance
- Available in two brands, two sizes, and by the box or by the case

Size / Brand	Item ID	Unit
1/4" (210/6) / Red Streak	W102	Box = 5000 staples
1/4" (210/6) / Red Streak	W102-A	Case = 100 boxes = 500,000 staples
5/16" (210/8) / Red Streak	W103	Box = 5000 staples
5/16" (210/8) / Red Streak	W103-A	Case = 80 boxes = 400,000 staples
1/4" (210/6) / Premium	W104	Box = 5000 staples
1/4" (210/6) / Premium	W104-A	Case = 100 boxes = 500,000 staples
5/16" (210/8) / Premium	W105	Box = 5000 staples
5/16" (210/8) / Premium	W105-A	Case = 100 boxes = 500,000 staples

W115 Heavy-Duty Stapler



- Flat and saddle stapler
- Manual lever action with a long handle for leverage
- Binds up to 55 sheets
- Easy-to-use clamp for mounting on any desk or bench

Specifications

- Actual weight: 6 lbs
- Shipping weight: 7 lbs
- Ships via: UPS
- Accepts only 1/4" (W118-D), 5/16" (W118-A), 3/8" (W118-E), and 1/2" (W118-B) heavy-duty staples shown below

W117R Heavy-Duty Stapler



- Fully adjustable 4" throat depth
- Powerful manual lever action with a long handle for leverage
- Binds up to 150 sheets
- Push button front loading
- Dual back-gauge stops adjust from 1/8" to 4"

Specifications

- Actual weight: 4 lbs
- Shipping weight: 5 lbs
- Ships via: UPS
- Accepts all sizes of heavy-duty staples shown below

W117L Heavy-Duty Stapler



- Long reach with a fully adjustable 10" throat depth
- Powerful manual lever action with a long handle for leverage
- Binds up to 150 sheets
- Push button front loading
- Dual back-gauge stops adjust from 1/8" to 10"

Specifications

- Actual weight: 6 lbs
- Shipping weight: 8 lbs
- Ships via: UPS
- Accepts all sizes of heavy-duty staples shown below

Heavy-Duty Staples



- Chisel point for the best performance
- 1000 staples per box
- Available in six sizes

Size	Sheet capacity*	Item ID
1/4" (23/6)	02 - 15 sheets	W118-D
5/16" (23/8)	15 - 35 sheets	W118-A
3/8" (23/10)	35 - 55 sheets	W118-E
1/2" (23/12)	55 - 75 sheets	W118-B
11/16" (23/17)	90 - 120 sheets	W118-C
13/16" (23/20)	120 - 150 sheets	W118-F

*sheet capacity is measured using 20 lb stock

W100 Number-Rite®



- Adjustable hit crash number through 8-part carbonless or delicate paper
- Numbering head may be set in any direction
- Head can be tilted forward or backward to make sure you get the best impression
- Number consecutive, duplicate, triplicate, 4 times, 6 times, 12 times, or repeat action
- Moveable / adjustable paper guides for simple registration

Specifications

- Solenoid: 115 Volt
- Actual weight: 13 lbs
- Shipping weight: 18 lbs
- Ships via: UPS

Note: Available with either Gothic or Roman type Numbering Head shown below

W100-L Lube And Clean (1 qt)



- Clean and lubricate the numbering heads in one easy step: Simply brush on and wipe away the excess ink. Don't wait until your machine becomes clogged; use it after each job to ensure crisp clean numbering and extend the life of your numbering head.
- Good for use on Lassco Wizer numbering machines along with Count Machinery, Graphic Wizard and all other brands of metal numbering machines.

Specifications

- Shipping weight: 2 lbs
- Ships via: UPS

W100-H Numbering Supply Kit



Includes...

- One bottle of black ink, one bottle of red ink, one bottle of blue ink, two green strike pads, two ink pad clips, twelve ink pads, and one stylus.

Numbering Head



- Six wheel numbering head
- Number from 1 to 999999
- Sinkable zeros
- Forward action
- Repeat numbering
- Available in Gothic or Roman type

Type	Font (to scale)	Item ID
Gothic	123456	W100-A
Roman	123456	W100-B

Numbering Ink



- Easy to apply...just saturate the ink pad and begin numbering

Color	Item ID
Black	W100-C
Red	W100-D
Blue	W100-D2

Numbering Accessories

Description	Item ID
Ink pad clip	W100-E
Ink pads	W100-F
Green strike pad	W100-G

W635 25" Score II

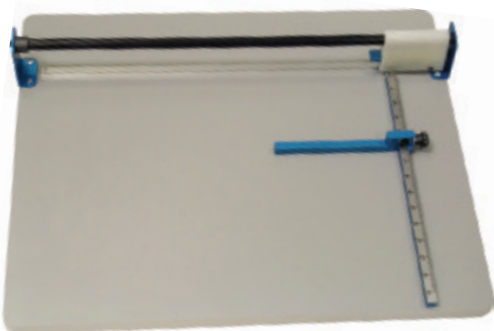

- Interchangeable perfining and scoring wheels
- Perforating wheel contains 10 perfs per inch
- Easily adjustable edge guide
- Can handle stock from 20 lbs to cover

Specifications

- Table size: 30" x 20"
- Actual weight: 16 lbs
- Shipping weight: 18 lbs
- Ships via: UPS

W630 19-1/2" Score II

- Same features as the W635 but a shorter perf/score track for smaller product

Specifications

- Table size: 24" x 20"
- Actual weight: 13 lbs
- Shipping weight: 15 lbs
- Ships via: UPS



NUMBER, PERF, SCORE, & CREASE

Perfmaster (XCM-A-PM)



- Desk top space saver model with optional stand
- Self fanning automatic bottom friction feed
- Easy set-up and operation
- Perf / score / slit depth control setting
- Quickly change from perforating to scoring
- Simple to use one button operation speed control
- Mount up to a maximum of four (4) perf or score assemblies
- Micro-lateral adjustments for easy set-up of perforating and scoring
- Feeds single sheets, coated stock, or multi-part open or glued edges

Specifications

- Power requirements: 110v 50/60 Hz
- Feed capacity: 18" wide
- Sheet capacity: 4" x 4" to 18" x 20"
- Max speed: 26,000 sheets per hour
- Actual weight: 66 lbs
- Shipping weight: 116 lbs
- Shipping dimensions: 36" x 36" x 42"
- Ships via: LTL

iCreaser



- Low Cost Hand Feed Design for Low to Medium Run Creasing
- Accurate Rotary Actuated Impact Creasing Eliminates Cracking
- Job Counter
- Automated Creasing Positions in Half, Tri-Fold, Z-Fold, and Letter Folds
- Comes with both standard and wide crease dies
- Custom jobs can be setup in moments and have up to 4 creases per page

Specifications

- Power requirements: 115/230 Volts 50/60 Hz 10A
- Max sheet size: 13" x 19"
- Min sheet size: 3" x 5"
- Stock weights: 16 lb - 16 point
- Actual weight: 50 lbs
- Shipping weight: 60 lbs
- Ships via: UPS

Auto Pro Plus Series



- 18" wide feed
- Patented self inking disposable ink cartridges
- Crash up to 10 part carbonless forms
- Deluxe seven wheel Gothic reverse numbering head with repeat sequences (repeat, consecutive, duplicate, triplicate, and 6 times; up to 3 drop-away zeros)
- Numbers virtually anywhere on a sheet

Specifications

- Power requirements: 110, 50/60 Hz
- Paper size: 4" x 4" to 18" x 20"
- Max speed: 19,000 sheets per hour

Machine	Functions / Feed Type	Ship Wt	Item ID
Number Pro Plus	Friction top feed with / One reverse numbering head / Includes one each perforating and scoring assemblies	200 lbs	XCM-NPP
Auto Pro Plus I	Friction bottom feed / One pneumatic reverse numbering head / Includes one each perforating and scoring assemblies (Requires air supply for numbering)	200 lbs	XCM-APPI
Auto Pro Plus II	Same as Auto Pro Plus I except comes with two pneumatic numbering heads	200 lbs	XCM-APPII
Accunumber Air	Same as Auto Pro Plus II except with bottom suction air feed (includes air pump and stand)	300 lbs	XCM-APPIIAIR
Optional Stand	Available for all the Friction feed machines	35 lbs	XCM-APSTAND

Note: All Air Feed models include a stand and a compressor.

W166 MasterPunch™ Plate Punch



- Punches paper, polyester, or metal plates
- 12" wide, open ended with adjustable plate guide for any width plate
- Punches 25 round holes at one time
- Pins are made from hi-strength alloy, heat treated to tool steel hardness for exceptional resistance to wear and abrasion
- Works great with A B Dick, Multi, Chief, Itek, Ryobi, Hamada, etc.

Specifications

- Number of pins: 25
- Pin size: 1 1/64" diameter
- Pin spacing: 1/2" center to center
- Pin throat depth: top of hole 17/64" from the edge of the plate
- Actual weight: 8 lbs
- Shipping weight: 9 lbs
- Ships via: UPS

W128 Remittance Envelope Feeder



- Feeds 500 envelopes at a time
- All metal construction for durability
- Feeds every size of remittance envelopes
- Fits most small presses

Specifications

- Actual weight: 4 lbs
- Shipping weight: 5 lbs
- Ships via: UPS

W125 Envelope Backstop



- Easy to install
- Runs envelopes at top speed without misfeeding
- For use with: A B Dick 350, 360, 375, 9820, 9840, and 9850

Blanket Bars



- Impervious to blanket wash and other chemicals
- Comes complete with necessary hardware

For Use With...

Item ID

A B Dick 360	W124
A B Dick 375 and 9800 series	W124-A
Quick change for A B Dick 360	W124-B
Quick change for A B Dick 375 and 9800 series	W124-C



INCOMING FREIGHT DAMAGE

Lassco Wizer packages all shipments to withstand normal handling with the intention that they will arrive at your facility in new condition; however, occasional shipping damage caused by the freight carrier will occur. There are two different types of freight damage: Visible and Concealed. To insure the proper handling of freight damage claims, please follow the procedures outlined below.

Visible Damage

- 1.) Inspect each carton for visible signs of damage and notate it on the bill of lading or delivery receipt. This includes small packages received through UPS, FedEx or any other small package carrier.
- 2.) If there is visible damage to the outside of the carton and you suspect damage to the merchandise, stop the freight carrier's driver and indicate that you would like to open the package in their presence.
- 3.) Open the package and check the merchandise for damage. Make sure to keep all the packaging material.
- 4.) If the merchandise is damaged, repackage the merchandise and refuse the shipment. Contact the dealer with whom you purchased the merchandise and explain that you had to refuse the shipment due to freight damage.

Merchandise that is accepted and signed for without notating visible damage or discrepancies becomes the property of the consignee and there are no guarantees for reimbursement by the freight carrier.

Concealed Damage

Concealed damage is when there is no visible damage to the outside of the carton, yet the enclosed product is damaged. Concealed damage must be reported to the freight carrier within fifteen (15) days of receipt of order.

- 1.) Inspect the merchandise while unpacking it from the shipping carton.
- 2.) If any product is damaged, stop unpacking and hold all shipping materials and merchandise for inspection.
- 3.) Contact the freight carrier's damage claim department and schedule an inspection of the shipment notifying them that there was concealed damage.
- 4.) Fax a copy of the inspection report to 800-854-6585.
- 5.) Do not ship the goods back to Lassco Wizer until after the inspection. If a claim is to be filed, the goods must be shipped back to Lassco Wizer via the same carrier that delivered it.

The burden of proof in a concealed damage claim rests on the shipper and the consignee to prove that the goods were properly packed in their containers, yet were damaged during transit. Concealed damage claims are difficult to prove and process successfully. If a concealed damage claim is not reported within fifteen (15) days of receipt, the claim will not be honored and there will be no reimbursement by the freight carrier.



LASSCO WIZER WARRANTY

All products manufactured by Lassco Wizer, including Spinnit® paper drills, LasscoJog® joggers, Cornerounder® corner cutters, and NumberRite® numbering machines shall conform to all specifications provided in our literature, catalogs, and operation manuals and shall be free from defect in material and workmanship at the time of delivery. Lassco Wizer's warranty extends for one year on all parts and labor excluding consumables and numbering heads. The Lassco Wizer warranty includes motors, valve systems, and head assemblies only so long as the products sold, as referenced, shall be used for the purpose intended and maintained in accordance with Lassco Wizer maintenance manuals supplied with the equipment. Lassco Wizer disclaims any liability from material or product failure in such event the buyer shall not follow the proper operation procedure outlined in the Lassco Wizer user's manuals. Lassco Wizer will repair or replace any part found to be defective within the warranty period. Any item returned to our factory must have a Return Authorization (RA) number provided by Lassco Wizer with all incoming freight charges paid for by the customer; Lassco Wizer will cover the return costs using the freight method of our choice. Consumables include, but are not limited to the following: drill bits, drill blocks, sharpening tools, belts, knobs, cutting units, screws, and hardware. Lassco Wizer numbering heads sold either individually or with our numbering machines are subject to a 90-day warranty. All products for which Lassco Wizer distributes but does not manufacture are subject to the original manufacturer's warranty. If you believe you have a warranty issue please contact your dealer.

RETURN POLICY

Standard products may be returned within 30 days of original invoice date with a mandatory re-stocking fee of 15%. All returns must be in like new condition with all original packaging and literature intact. All returns must have a Return Authorization (RA) number provided by Lassco Wizer. Unauthorized returns will be refused. Cost of repackaging and reconditioning will be deducted from any accepted return for credit in addition to the 15% re-stocking fee, if not returned in like new condition. All defective items will be inspected prior to a credit being issued. Shipping charges on merchandise accepted for credit must be prepaid with all freight charges incurred by the customer.

YOUR **Lassco**  **Wizer** DEALER IS

PLEASE CONTACT YOUR DEALER SHOWN HERE FOR PRICING AND ORDERING