

# User Manual



# ES8000



Introduction

---

Introduction	2
Specifications	3
Identifying Parts	4

Installation

---

Installation	7
--------------	---

Operation

---

OP Panel	8
Paper Loading	9
Fold Type Setting	11
Understanding Folding Mechanism	12
Functions	20

Trouble Shooting

---

Error Code	22
Paper Jam	23
Others	24

Maintenance

---

Replacing In-Feed Roller	25
Roller Cleaning	26

### Introduction

## Welcome!

Thank you very much for selecting a Paitec USA product!

This manual is prepared to provide you with guidelines on how to properly operate and maintain the ES8000. Please read this user manual before operating in order to prevent unexpected malfunction or damage. Please refer to the manual carefully and follow the instruction.

## Copyright 2014

Any of the contents should not be copied, re-printed or translated by other languages without Paitec USA approval.

## Safety Precautions



---

Caution: Serious bodily injury or mechanical damage may result from

insufficient attention to or incorrect compliance with warning messages using this symbol.

---

- Do not attempt to disassemble or reorganize the machine. It may cause an electric shock or mechanical problem.
- Quickly disconnect the power if liquid or a foreign object enter the inside of the machine.
- Do not enter metal or inflammable material into AC Inlet.
- Please contact local dealer when you relocate the machine.
- This manual is subject to be revised without notice for product improvement.
- Do not install the machine on the place as below.
  - Near window or places exposed to direct sunlight.
  - Where vibration is detected.
  - Sudden temperature changes or poorly ventilated areas.
  - Places exposed to hot or cold air directly. (not office circumstance)
  - Not solid enough or weak floor.

# Specifications

## Features

- ES8000 is a midrange level of pressure sealer. Speed processing up to 8,000 sheets per hour, perfect sealing quality with 2 ½" of pressure rollers, duty cycle up to 150,000 sheets per month.
- Friction Reverse Rollers (FRR) Technology for papers separation. High Capacity Top Feed Elevator Infeed Table. Snap-on Easy Feed Roller Replacement. Double Feed Sensor Alert System.

## Specifications

Specifications	
Form Size	A4 / Legal / Letter
Paper Weight	20#-28#
Speed	Max 8,000 sheets per hour
Fold Setting	Manual
Fold Type	Z, C, V, EZ
Double Feeding Detect	Available by DFD sensor
Stacker	Optional: Vertical Stacker, Slide Conveyor
Duty	150,000 / month

### Identifying Parts

#### Main Body

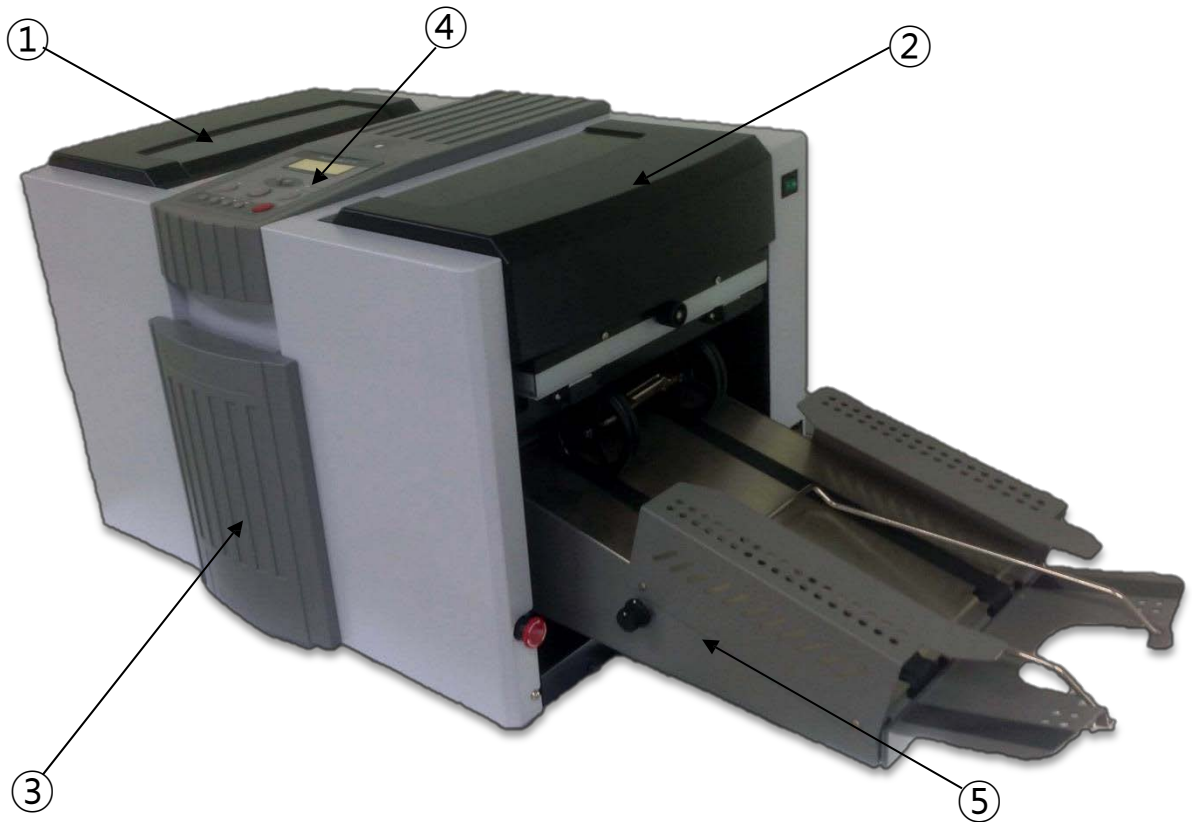

- ① Feeding Unit Safety Cover
- ② Upper Fold Cassette Safety Cover
- ③ Lower Fold Cassette Door
- ④ OP Panel
- ⑤ **Conveyor (optional)**

## Identifying Parts

### Large Capacity Table

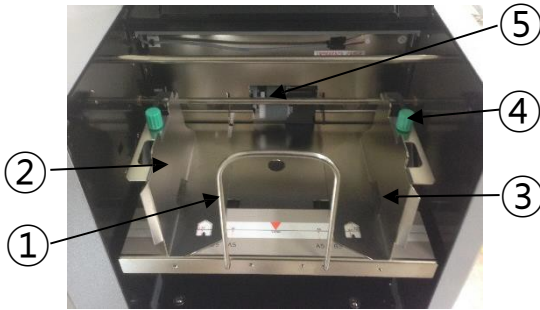

- ① Papers Support Hanger
- ② Feed Guide (Left)
- ③ Feed Guide (Right)
- ④ Locking Knob
- ⑤ In-feed Roller

### Lower Cassette

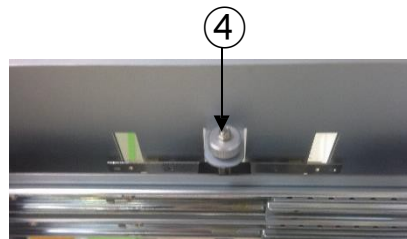
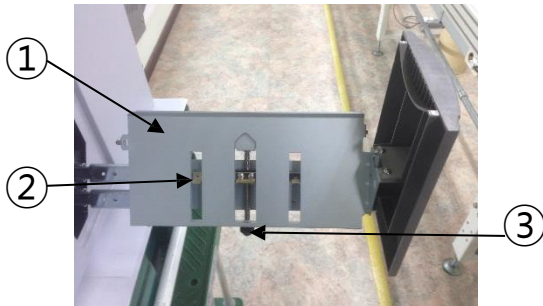

- ① Lower Cassette
- ② Stopper
- ③ Stopper Adjustment Knob
- ④ Stopper Locking Knob

### Upper Cassette

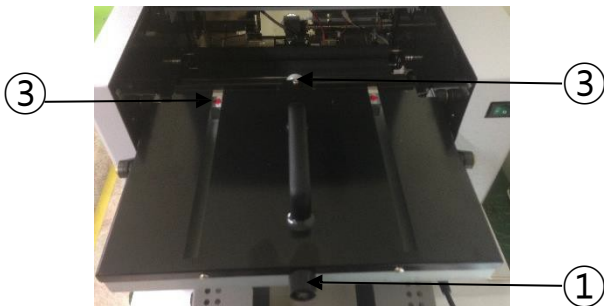

- ① Stopper Adjustment Knob
- ② Stopper Locking Knob
- ③ Fold Position Marker

Identifying Parts

Out-Feed Unit

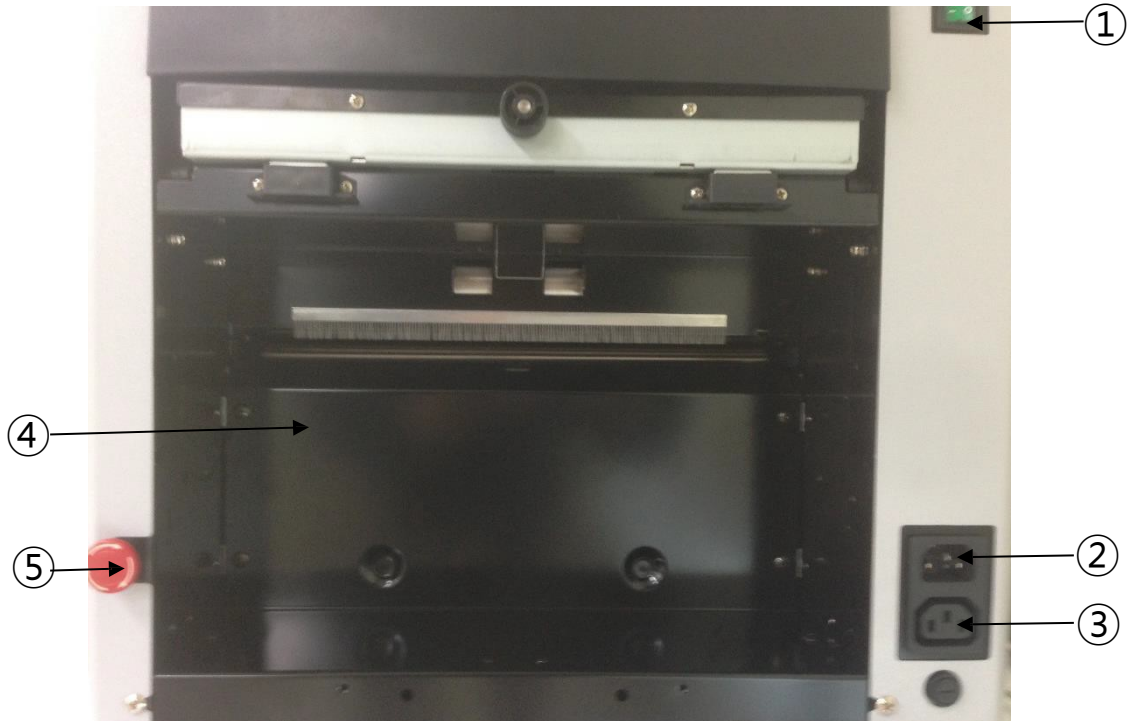

- ① Power Switch
- ② Main Power Socket
- ③ Conveyor Power Socket
- ④ Press Roller Cover
- ⑤ Emergency Switch

### Installation

#### **Installation Environment**

1. Input power : 100~110V
2. Machine size(inches) : 24" x 18" x 16" (without conveyor)
3. Machine weight : 99Lbs
  - Weight of a product is heavy, please use appropriate table for putting it on.
  - Please use grounded power cable.

#### **Unpacking**

Please check if all of the following parts are included in the box.

- Main body, Power Cord, User's Manual, V-Fold Guide and Jam Removal handle.

#### **Removing Safety Tape and Styrofoam Location**

Please remove all safety tapes and Styrofoam before operation.

#### **Power Connection**

Please refer to the label for electric information which is located at the back side of the machine. When the power cable is properly connected, please switch the machine on and check whether 'Ready' sign is appear on the display panel.

If not, please contact your local dealer for service.



OP Panel

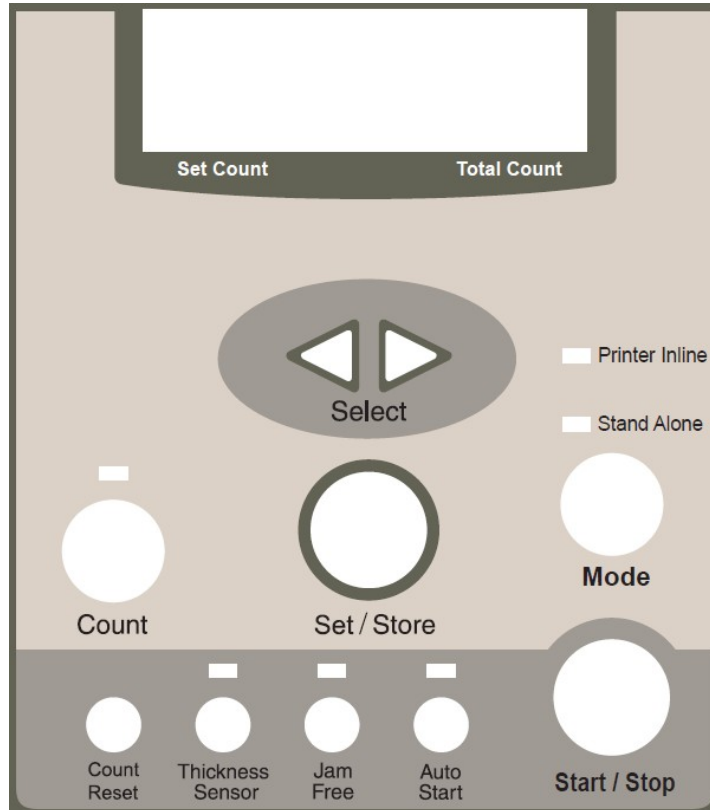

1. Start/Stop button: starts and stops the machine. If you press during setting, it returns to the prior condition.
2. Set/Store button: sets and stores the selected function.
3. Mode button: enters to mode function.
4. Count button: enables you to set the number of forms that you wish to process and have the machine stop automatically until you press the start button.
  - Press the counter button and the light will blink.
  - Change the displayed value by using select button and when ready, press the set button.
  - When changing the value, press batch counter button to increase the value by 50 up to 500.
  - This setting is not stored after rebooting the machine.
5. Select button: selects yes/no or increase/decrease numerical value when you set.
6. Count reset button: clears the count on the display panel.
7. Thickness Sensor button: protects the double or multiple feeding by sensing the characteristics of paper.
8. Jam free button: automatic removal of paper jam at folding roller or press roller.
9. Auto start button: re-starts the process after selected time when the job reaches preset count.

# Paper Loading

## Paper Size

ES8000 can handles any form that is larger or smaller than the following forms.

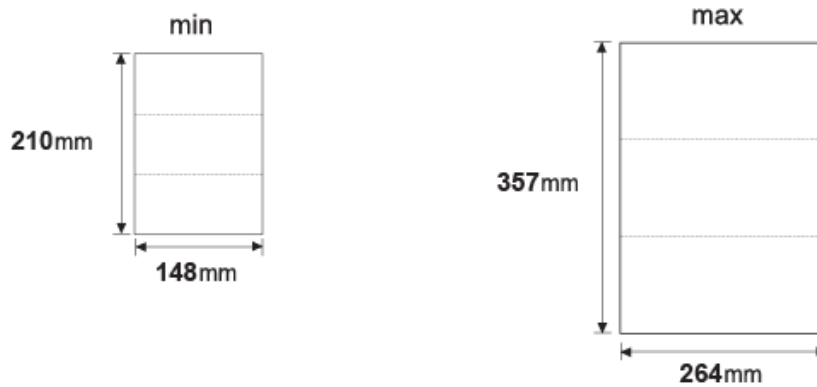

## Paper Feeding

1. Before loading the forms onto the machine, please make sure all forms are aligned and fanned. Please refer to the images below.

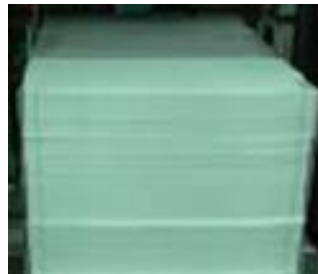
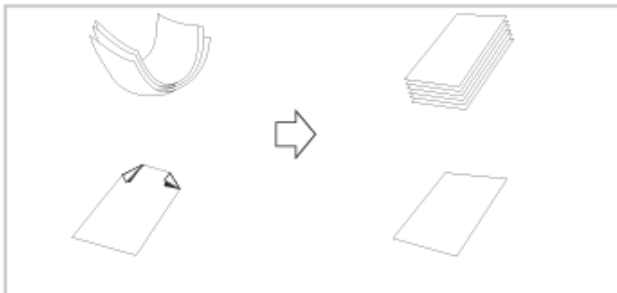

Good



Bad

If the condition of forms are not good as the picture above (Bad), place appropriate quantity of forms, unless forms will be jammed.

### Paper Loading

2. Open the safety cover of the feeding unit. The tray will go down.
3. When the feed tray is down to the bottom, loosen the green knobs on both paper guides.
4. Load the aligned forms onto the feed tray and adjust the paper guides so they are gently covering the sides of the stacked forms.



- 5 Tighten back the green knobs on both paper guides.
6. Once loading is complete, please close the safety cover. The feed tray will go up.



#### Caution

- Poor quality forms may cause frequent paper jams.
- Make sure the paper guides are not set narrower or wider than the width of the paper.

### Fold Type Setting

#### Setting of Paper and Folding Type

The following instruction shows how to set 8 ½ x 11" Letter size Z-Fold.

(Note: Please be noted that the position marker doesn't guarantee 100% positioning)

##### 1. Lower Cassette Fold Setting - 93mm



- 1) Unlock the fold position of the lower cassette by turning the stopper locking knob counter clockwise.
- 2) Adjust the stopper so the surface of the rubber is lined up at 93mm.
- 3) Lock the stopper by holding the stopper adjustment knob and turning the stopper locking knob clockwise.

##### 2. Upper Cassette Fold Setting - 93mm

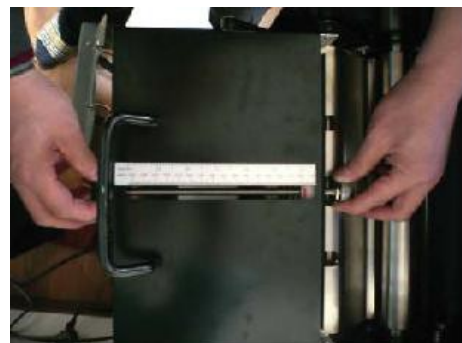
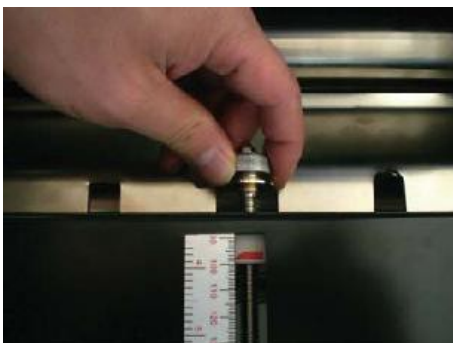

- 1) Unlock the fold position of the upper cassette by turning the stopper locking knob counter clockwise.
- 2) Adjust the stopper so the red marker is lined up at 93mm..
- 3) Lock the stopper by holding the stopper adjustment knob and turning the stopper locking knob clockwise.

## Understanding Folding Mechanism

It is important to understand how ES8000 folds paper in order to accurately set the fold setting. Please read the following information carefully to fully understand the folding mechanism of ES8000.

1. The folding unit is composed of rollers, cassettes and stoppers.

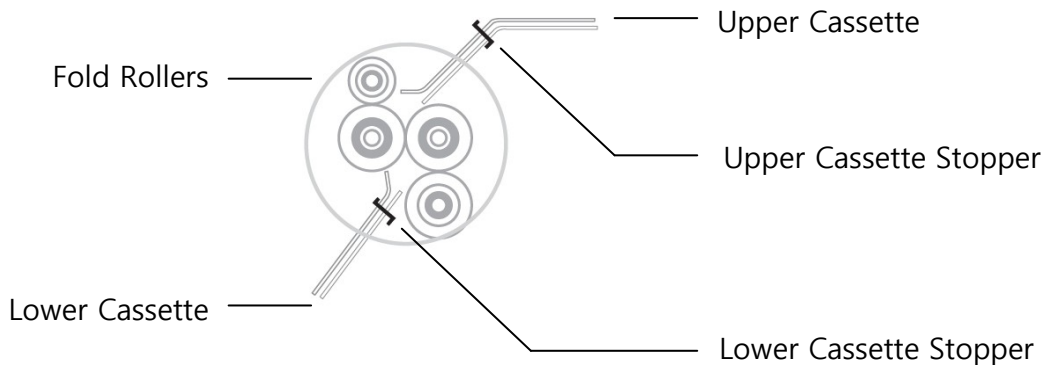

2. The form enters in between the two front fold rollers.

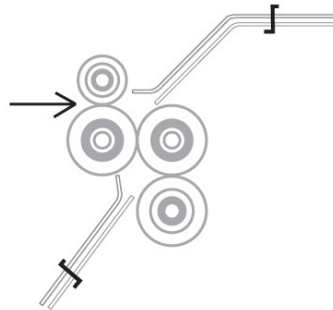

3. The form hits the upper cassette stopper and buckles in the middle. Then the folded portion enters in between the middle two rollers.

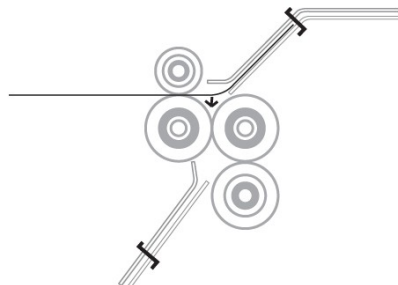

## Understanding Folding Mechanism

4. The form hits the lower cassette stopper and forms a buckle. The folded form then enters in between the two outer rollers.

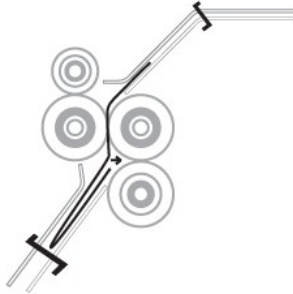

5. The folded form then exits the fold rollers and then are sent to the press unit.

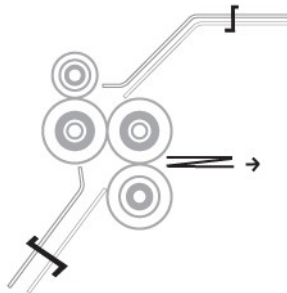

# Understanding Folding Mechanism

## Z-Fold Setting

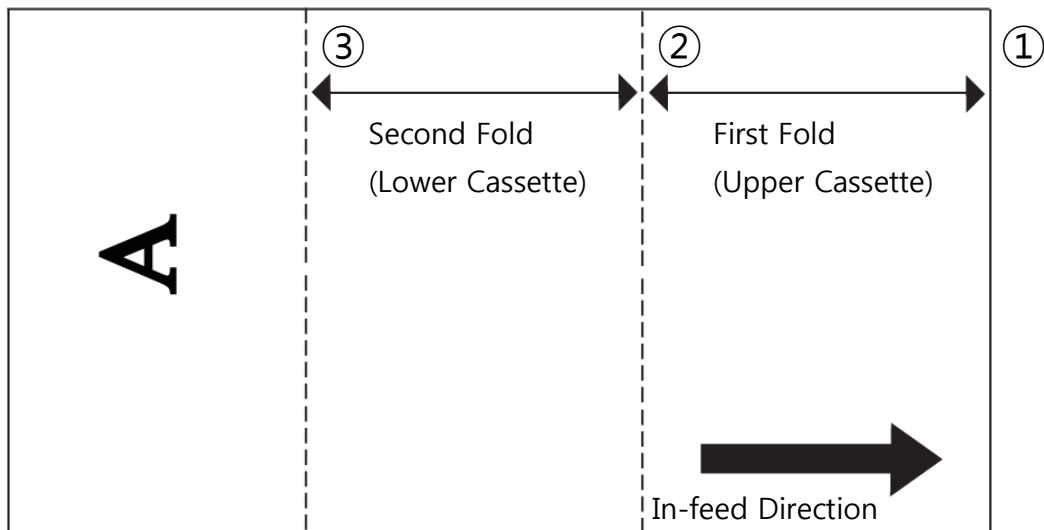
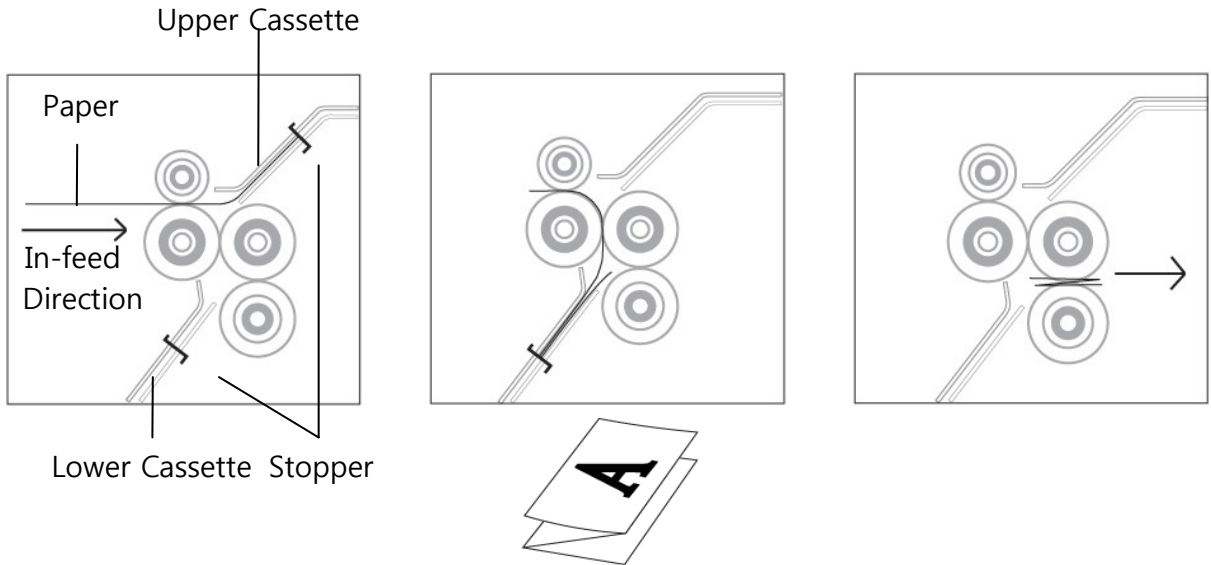

When setting a Z-Fold, please read the following steps.

1. Measure the length from line 1 to line 2 of the form as indicated in the image above. That measurement is the fold setting for the first (upper cassette) fold.
2. Measure the length from line 2 to line 3 of the form as indicated in the image above. That measurement is the fold setting for the second (lower cassette) fold.

# Understanding Folding Mechanism

## V-Fold Setting

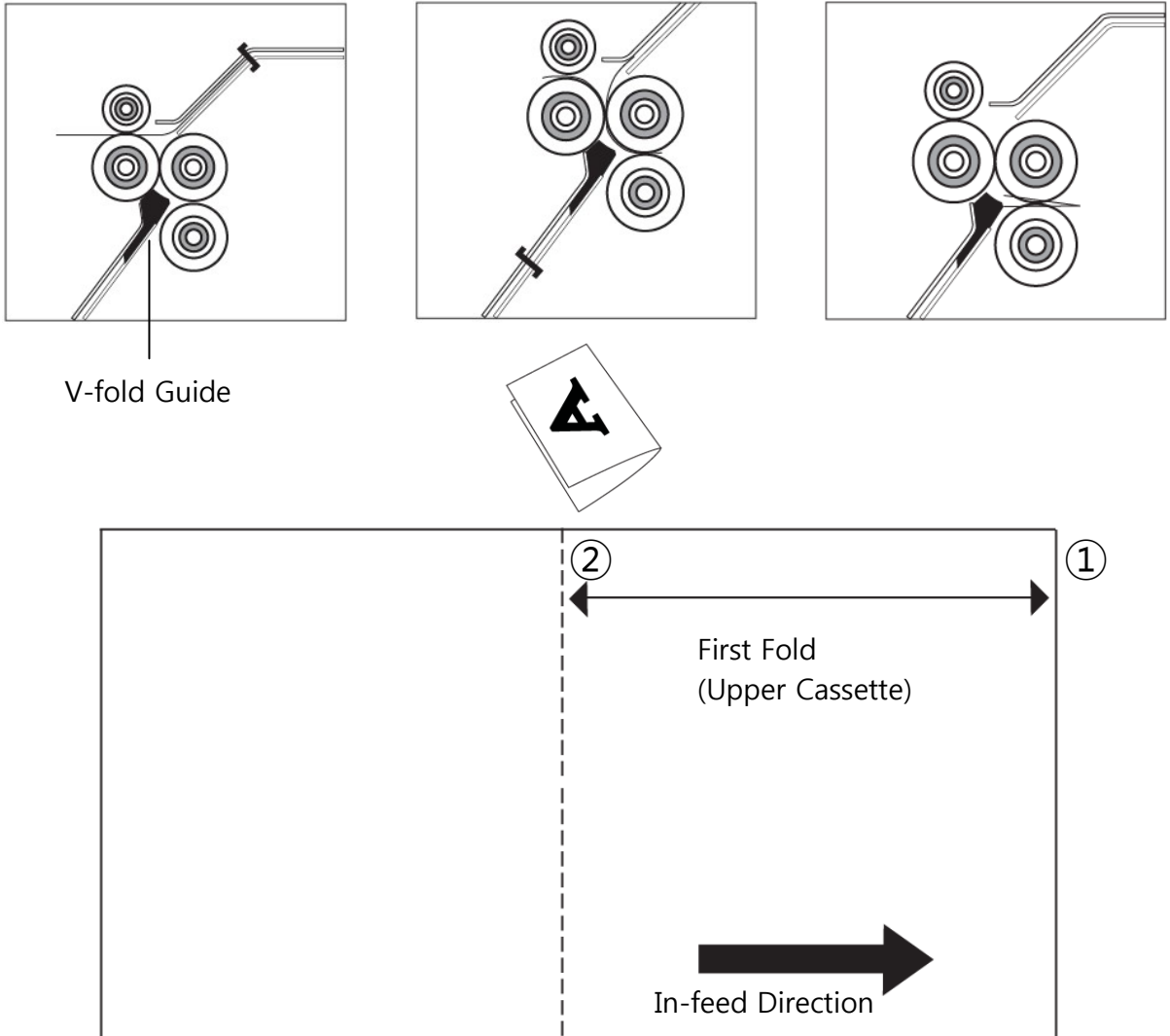

When setting a V-Fold, please read the following steps.

1. Measure the length from line 1 to line 2 of the form as indicated in the image above. That measurement is the fold setting for the first (upper cassette) fold.
2. Make sure the V-fold guide is placed at the entrance of the lower cassette.



Understanding Folding Mechanism

**C-Fold Setting**

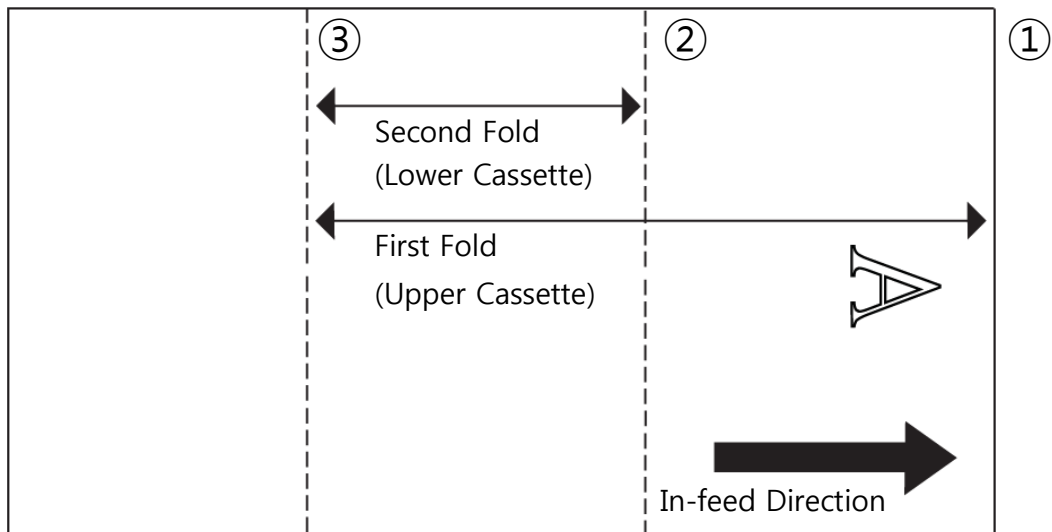
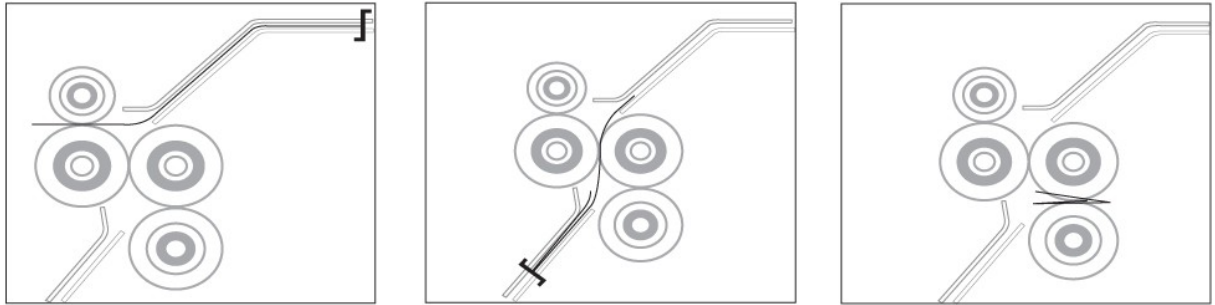

When setting a C-Fold, please read the following steps.

1. Measure the length from line 1 to line 3 of the form as indicated in the image above. That measurement is the fold setting for the first (upper cassette) fold.
2. Measure the length from line 3 to line 2 of the form as indicated in the image above. That measurement is the fold setting for the second (lower cassette) fold.

## Understanding Folding Mechanism

### Double-Fold Setting

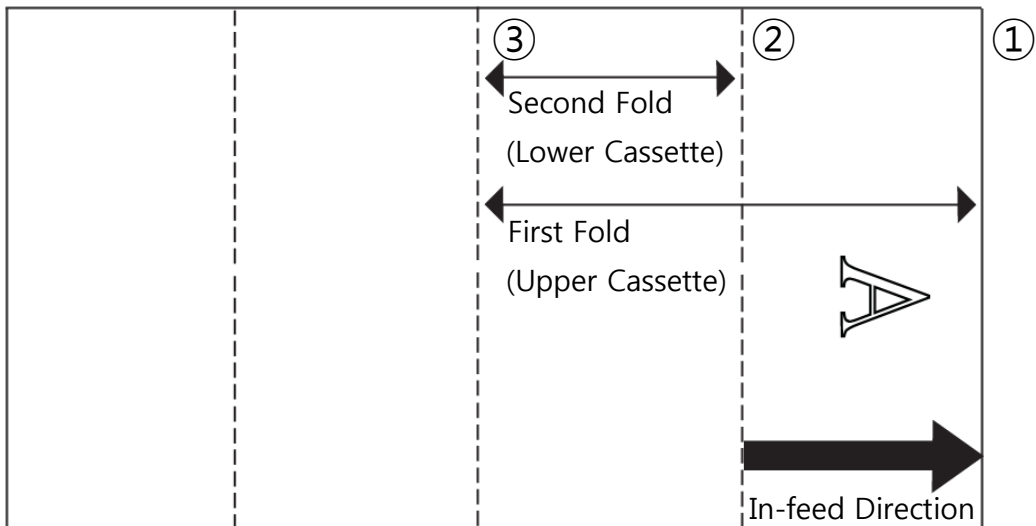
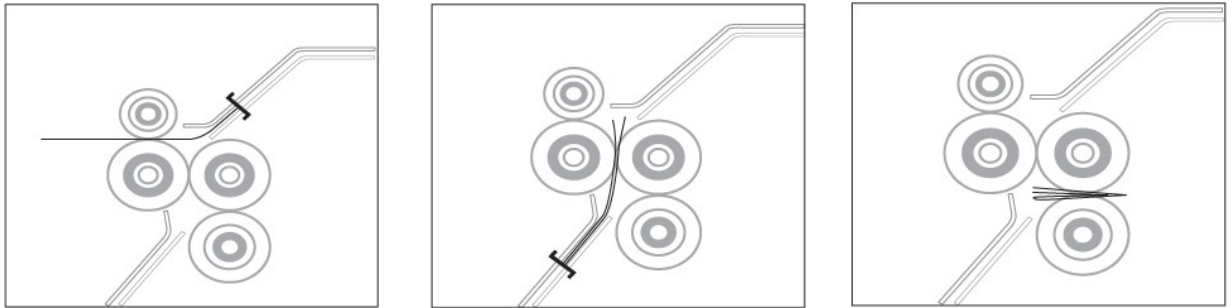

When setting a Double-Fold, please read the following steps.

1. Measure the length from line 1 to line 3 of the form as indicated in the image above. That measurement is the fold setting for the first (upper cassette) fold.
2. Measure the length from line 3 to line 2 of the form as indicated in the image above. That measurement is the fold setting for the second (lower cassette) fold.

## Understanding Folding Mechanism

### Window-Fold Setting

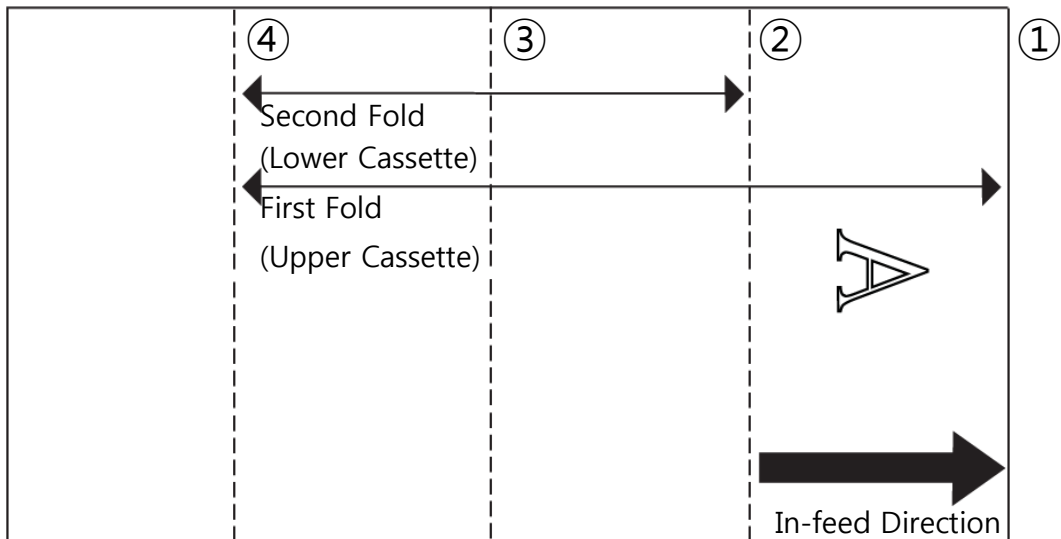
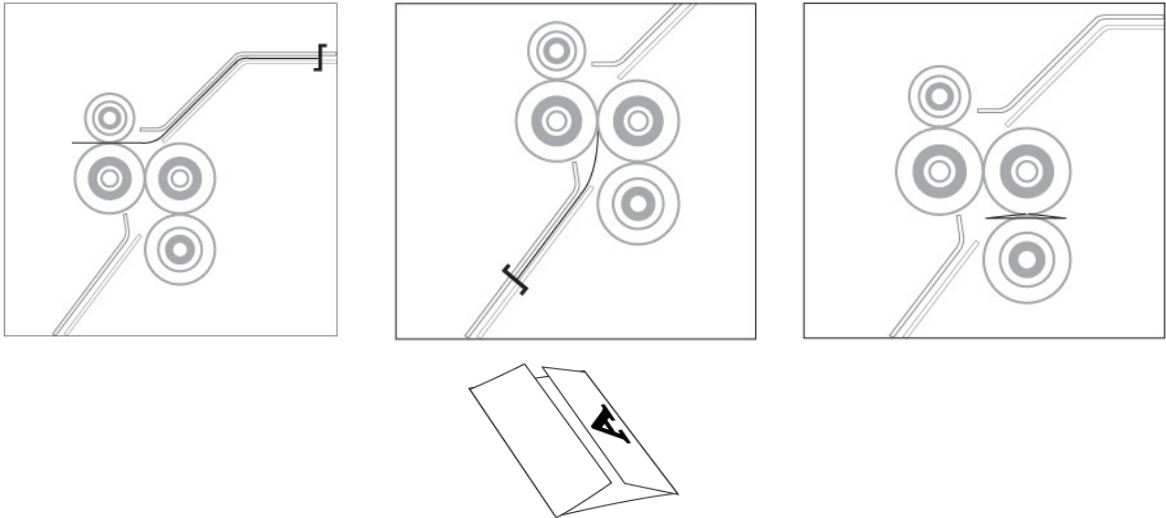

When setting a Window-Fold, please read the following steps.

1. Measure the length from line 1 to line 4 of the form as indicated in the image above. That measurement is the fold setting for the first (upper cassette) fold.
2. Measure the length from line 4 to line 2 of the form as indicated in the image above. That measurement is the fold setting for the second (lower cassette) fold.

### Understanding Folding Mechanism

#### Fine Adjustment of Folding Position

You can adjust the fold setting in the following cases.

1. Fine adjustment is required from the standard folding type.
2. In case the folding is slightly different.



Reference

If the folding is slightly off from the desired position, please check the following possible causes.

- a. Incorrect fold setting
- b. Machine clearance
- c. Incorrect position of fold cassettes
- d. The FRR or the fold rollers are worn out

### Functions

#### Count Setting

You can set the number of jobs to be done.

For example, if you set count on 100, machine will stop operating when the job reaches 100. Press Start/Stop button again, machine will start to finish another 100.

1. Press Count button and the LED will light on
2. Select job volume by using - / + button.
  - \* If you press the button on by one, count will change by 1 and if you press for more than one second, the count will change by 10/second.
3. Press Set button and check the number displayed on the panel.
  - \* You can set the counter up to 250 sheets.

#### Use of "Auto Start" Function

In case you need job separation, you do not have to press Start button again.

1. Press the button. Then 'Time Interval' will be displayed on the panel. Select the desired delay time by second with - / + button.
2. Press Set/Store button.
3. Max. 10 seconds of delay time can be set.



#### Reference

For example, in case count set to 10 and Auto Start time interval set to 3 seconds, after 10 products, machine will stop for 3 seconds. LED will blink. 3 seconds later, it will work again.

If you switched off the power and on, you have to set the function again.

### Functions

#### Thickness Sensor

This function prevents double or mass feeding.

1. Press the Thickness Sensor button.
2. It will feed on paper and stop at the digital sensor for a second.
3. The thickness of the paper will be shown on the panel in digital value and paper comes out. Check if LED is on.
4. Press Start/Stop button and it works. If double or multiple papers feed at the same time, machine will stop before the paper goes into folding roller and Error #5 will be displayed on the panel.



Reference

Whenever you change the paper, you are requested to off and on the Thickness Sensor button since the value is different depending on papers.



Reference

This digital value won't change by turning on/off the power.

#### Use of "Jam Free" Function

In case the paper is jammed at folding roller or press roller, machine will stop with error message. Then, press Jam Free button and machine will run except feeding unit. If it is still not possible to remove the jam, Please refer to P.23 Paper Jam

Error Code

**Error Message**

There are various types of sensors located at different parts of ES8000. These sensors detect and display the location of an error on the panel. Please read the following errors to understand how to handle each error.

**Error Message**

Lower Cassette Missing	Push the cover of Lower Folding cassette until it is installed.
Close Left Cover	Safety Cover of feeding unit is open. Close the cover.
Close Right Cover	Safety cover of Upper folding cassette is open. Close the cover.
Out of Paper	There is no paper on paper tray. Supply paper.
Not Available	The selected folding is not available. Choose other folding type.
Error #5	Double feeding happened. Open the safety cover of feeding unit and remove the paper jam under pickup roller.
Error #6	Paper jam on feeding unit. Open the safety cover of feeding unit and remove the paper jam.
Error #7	Paper jam inside the main body . Take out the Upper / Lower folding cassette and remove the paper.
Error #8	Memory storing error. Try again.
Error #9	Paper jam in the folding cassette. Take out the upper / Lower cassette and remove the paper.
Error #A	Paper jam in press roller. Press "Jam Free" button on control panel. If it doesn't work, remove jam according to picture on Delivery unit.
Error #B	Paper jam in front of press roller. Take out the Upper / Lower Folding cassette and remove the paper.
Error #C	Paper jam in front of folding roller. Take out the Upper / Lower folding cassette and remove the paper.
Error #0~3	Call the service.

### Paper Jam

#### Removing the jammed paper at the upper cassette

1. Open the top upper cassette safety cover.
2. Pull out the upper cassette and remove any jammed paper.



#### Caution

Please be cautious when removing jammed forms as it may result in damaging the upper cassette.

#### Removing the jammed paper at the lower cassette

1. Open the lower cassette cover.
2. Remove any jammed paper

#### Double Feed

1. Try to remove the jam by using the jam free button.
2. If the jam is not cleared by using the jam free button, please use the jam removal handle to manually remove the jam.



When removing the jam, turn the press rollers by inserting the jam removal ratchet and turn it clockwise like the picture.



#### Caution

1. Turn off the power
2. Never operate the machine with the jam removal handle set up



#### Important

The press rollers are designed to accept 20~28# forms. Any forms that are heavier may affect the machine to malfunction.



### Others

Some of the errors can easily be fixed by the user without a professional's aid.

#### **No Power**

1. Check whether the power cable is properly connected.
2. Check the (red) Emergency Switch.
3. Check the electric source.

#### **Incorrect Folding**

1. Please re-set the paper length and folding type.
2. Check if the initial folding position (home position) is same as ex works setting.

#### **Power On, but No Start**

1. Check if the left safety cover is opened.
2. Check if the right safety cover is opened.
3. Check if the lower cassette is pushed all the way in.
4. Check for any paper jams.

#### **Frequent Double or Multiple Sheet Feeding**

1. Change the Infeed Roller Set. Rollers are probably worn-out.
2. Check if the adhesive of the paper is too strong or static. Please align the paper again and feed.
3. If the paper weight is too light (below 20#), contact the service engineer.
4. Some part of paper is bent.
5. After you have changed the paper, you are requested to press Thickness button again (off and on) since the thickness of each paper should be different.
6. Paper side guide is not set correctly. Please check if it is too tight or too loose.

## Replacing InFeed Roller Set

### Exchanging Friction Reverse Roller

The feeding rollers consist of three different rollers.

1. Pickup Roller
2. Feed Roller
3. Separate Roller

It depends on the paper weight, type and etc., but please check the parts and change when you produce over 100,000 products, if necessary. How to change the parts are as follows.

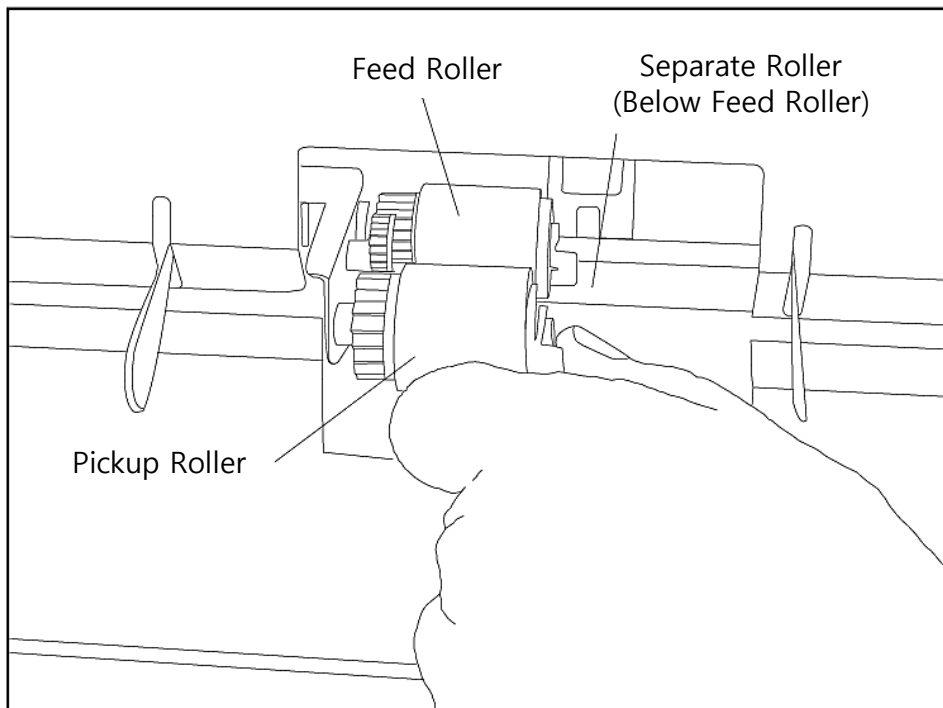

1. Remove the snap ring (white clip).
2. Replace the roller and place back the snap ring.
3. Follow step 1 & 2 for the rest of the rollers.

### Roller Cleaning

#### Cleaning Rollers

Since pressure seal forms leave paper dust, ink and toner residues, it is very important to occasionally clean the surface of the each roller to maintain its best condition for better performance.

1. Paper dust
  - Use small air cleaner or dust remover.
2. Cleaning fold rollers
  - Open the safety cover and slide out the upper cassette. With a piece of soft cloth, use alcohol or water to remove any ink contamination or toner residues on the surface of the fold rollers.



#### Caution

Please do not use any other substance when cleaning the surface of the fold rollers as it may damage the rubber.

### Roller Cleaning

#### 3. Cleaning press rollers

- We suggest you hire a professional service technician for this task.  
If you are going to do it by yourself, please turn off the power or unplug the power cable.
- Clearing lower press roller: Open the safety cover of press roller as picture A. Then, please clean the press roller shown in picture B.
- Clearing upper press roller: Open the upper folding cassette as picture C and clean the press roller.



Picture A



Picture B



Picture C

## Service notes

---

Memo



Memo

Memo



<http://www.paitec.com>

---