



AL-MEISTER

ALM3230



Instruction Manual

Thank you very much for purchasing the FUJIPLA ALM3230 Auto Laminator. Due to the potential for damage and for personal safety reasons only trained personnel should operate this machine! Please read through this manual carefully before operation. Please keep this manual and refer to it whenever necessary.

Ver 1.0 [US]

Ver 2 by Brian Jennett (includes Ver 1.0 [US]) 12/14/15, 1/27/16, 3/2/16, 5/11/16



DryLam Publications

23220 W. 84th St., Shawnee, KS 66227

Phone: (888) 633-1973

Brian Jennett- Tech-Line/Service Manager ext 8575

www.DryLam.com

DryLam LLC is the exclusive distributor of Fujipla products in North America. Contact DryLam’s Tech-Line at 888-633-1973 x8575 or brianj@drylam.com with any service related inquiries. Other information is available on our website at www.drylam.com



Contents

SPECIFICATIONS	4
MAXIMUM PAPER THICKNESS	5
MAIN FEATURES.....	6
IMPORTANT SAFETY PRECAUTIONS.....	7
GENERAL CAUTIONS	9
REQUIREMENTS OF PAPER TO BE LAMINATED	10
RECYCLING INFORMATION	10
INCLUDED COMPONENTS	11
2. NAMES AND FUNCTIONS	12
2-1. EXTERIOR	12
2-2. INTERIOR.....	13
2-3. OPERATION PANEL.....	14
2-4. LCD DISPLAY.....	15
2-5. OTHER SWITCHES AND BUTTONS.....	17
3. INSTALLATION	19
3-1. INSTALLING THE ALM3230.....	19
3-2. SET FEEDER TRAY	19
3-3. SET EXIT TRAY	19
3-4. SET WASTE COLLECTION BOX.....	21
3-5. CONNECT POWER CORD.....	21
4. SET LAMINATION FILM/MANUAL MODE.....	22
5. AUTOMATIC OPERATION	35
5-1. WARM UP	35
5-2. SETTINGS.....	36
5-2-1. SET TEMPERATURE	36

DryLam Publications

23220 W. 84th St., Shawnee, KS 66227

Phone: (888) 633-1973

Brian Jennett- Tech-Line/Service Manager ext 8575

www.DryLam.com

5-2-2. FIXED SPEED SETTING	36
5-2-3. SET TRIMMER MARGINS.....	37
5-2-4. MODE MENUS	39
5-2-5. SET COUNT.....	41
5-2-6. MARGIN SET	43
5-2-7. CUT ADJUST	44
5-2-9. PAPER FEED ADJUST (SOFTWARE).....	46
5-2-10. TOTAL COUNT.....	47
5-2-11. CHECK FILM INFO.....	48
5-2-12. PAPER FEED RESIST ROLLER PRESSURE ADJUSTMENT (MECHANICAL).....	49
5-2-13. PAPER SKEW ADJUST	51
5-3. SET PAPER	52
5-4. START OPERATION	54
5-5. ECO MODE (Power Saving Mode).....	55
5-6. TERMINATE LAMINATION.....	55
6. LONG MODE.....	56
7. TROUBLESHOOTING/ERROR MESSAGES.....	57
8. CLEANING THE HEAT ROLLERS.....	62

DryLam Publications

23220 W. 84th St., Shawnee, KS 66227

Phone: (888) 633-1973

Brian Jennett- Tech-Line/Service Manager ext 8575

www.DryLam.com

SPECIFICATIONS

Feature:	Model ALM3230	
	Minimum	Maximum
Feeder Tray Capacity	1 page	200 pages (20# copy paper), less for thicker paper
Paper Width	8-1/8"	12.6"
Finished & Trimmed Width	8-9/16"	13"
Paper Length	6-1/2"	20" in normal mode, unlimited length in "LONG MODE"
Operating Temperature	170 degrees F	270 degrees F
Operating Speed (in. per min.)	40	
Finished Size (W x L) and Trimming Methods of Common Paper Sizes	Letter (8.5" x 11"); With Margin: 8.74" X 11.24"; Without Margin: 8.5" X 11".	
	Double Letter (11" x 17"); With Margin: 11.24" X 17.24"; Without Margin: 11" X 17"	
	Digital Paper (12" x 18") With Margin: 12.24" X 18.24"; Without Margin: 12" X 18"	
Maximum Laminated Thickness	16mil (.016") (including film thickness)	
Exit Tray capacity	200 pages (20# copy paper laminated with 5mil film), less for thicker paper	
Warm-up Time	Approx. 15 minutes	
Power Source	AC 120V 60 Hz	
Power Consumption	1200W, 10A	
Dimensions (W x L x H)	50.1"(W) X 24.8"(D) X 18.5"(H) including Feeder Tray, Feeder Tray Extension and Exit Tray installed. (Not including Stand.)	
Weight	Laminator : 97 LBS; Optional Stand : 52.9 LBS	
Environmental Restrictions	Within the range of 32F to 86F (68 +/- 40F recommended)/an altitude below 6600'.	
Accessories	Feeder Tray -- Extension Feeder Tray -- Exit Tray -- Power Cord -- Waste Collection Box	

DryLam Publications

23220 W. 84th St., Shawnee, KS 66227

Phone: (888) 633-1973

Brian Jennett- Tech-Line/Service Manager ext 8575

www.DryLam.com

SPECIFICATIONS (cont'd)

MAXIMUM PAPER THICKNESS

The ALM3230 will accept a maximum of 16 mil combined paper/film thickness.

This table shows maximum paper stock thickness given the thickness of the film being utilized:

ALM3230 Maximum Paper Thickness Table										
Available film thickness	Based on 16 mil maximum film/paper thickness									
	1	2	3	4	6	8	10	12	14	16
1.2mil Single sided	Film	14.8mil paper = (120# cover, 180# index, 312 gsm)								
1.5mil Two sided	Film		13mil paper = (105# cover, 158# index, 206 gsm)							
3mil Two sided	Film				10mil paper = (90# cover, 135# index, 245 gsm)					
5mil Two sided	Film						6 mil paper = (40# cover, 60# index, 162 gsm)			

Table 1

For example, looking at Table 1 above, when laminating two sides of a sheet with 5 mil film, the film itself is 10 mil's thick. Hence, paper stock can be no thicker than 6 mil. 6 mil thickness equates to 40# cover or 60# index.

This is more of a limitation of the Cutter and Trimmer Units than it is of other areas (feeding, laminating) of the laminator. When cutting and trimming film only (in other words, outside the paper area) it MAY be possible to process UP TO 120# cover (#180# index) regardless of the thickness of the film utilized.

DryLam Publications

23220 W. 84th St., Shawnee, KS 66227

Phone: (888) 633-1973

Brian Jennett- Tech-Line/Service Manager ext 8575

www.DryLam.com

MAIN FEATURES

The AL-MEISTER ALM3230 is a fully automatic hot laminator that will feed, laminate, cut and trim around all four sides of paper. Once threaded and set up properly, place printed paper on the Feeder Tray and press the [START] button for full automatic operation.

1. Laminating Size/Laminating Film:

Letter/Double Letter/Digital sized paper can be laminated automatically. The film is specially produced. Glossy and matte types are available.

2. Finish with, or without margin:

With margin: The ALM3230 will trim leaving a 0.11" margin of film outside the edge of the paper. The paper is completely encapsulated to enhance durability and resistance to liquids.

Without margin: The ALM3230 will trim laminated paper to the paper size. The surface of the paper is protected with the edges exposed.

3. Feeds 200 sheets automatically:

Automatic feeding of up to 200 sheets on the tray enables fully automatic operation.

4. Speedy Lamination:

Any manual preparatory tasks that were needed in traditional encapsulation are now unnecessary. It takes only 3 minutes to laminate 10 sheets of letter size paper.

5. Eco Mode saves power consumption:

For more details, see ECO MODE (Power Saving Mode).

DryLam Publications

23220 W. 84th St., Shawnee, KS 66227

Phone: (888) 633-1973

Brian Jennett- Tech-Line/Service Manager ext 8575

www.DryLam.com

IMPORTANT SAFETY PRECAUTIONS

The following safety precautions must be observed for your safety during the operation of this product. Please read the cautions and warnings carefully. Please keep this manual and refer to it whenever necessary.



General Caution



Electric Shock Indicates the potential for electric shocks.



Tangling Warning Indicates possible injuries caused by tangling in a rotating machine part.



Amputation Warning Indicates possible serious injuries such as finger amputation.



Heat Warning Indicates the potential for injuries caused by extreme heat.



Don't Do Indicates unspecified acts that are forbidden.



Unplug immediately Indicates a dangerous situation. Unplug the ALM3230 from the wall outlet and call for service.

These two different words are used on the machine according to the level of danger.



WARNING In the case of incorrect use, there can be serious injury.



CAUTION Injury to the operator or damage to equipment possible. There can also be a machine malfunction.

DryLam Publications

23220 W. 84th St., Shawnee, KS 66227

Phone: (888) 633-1973

Brian Jennett- Tech-Line/Service Manager ext 8575

www.DryLam.com

INSTALLATION

To avoid fire, electric shock, or any danger, do not install the machine in a place like:



In direct sunshine or near an air conditioner.



In an extremely humid/dry area.



In an extremely cold area.



In/near a heating appliance or extremely hot area.



In an extremely dusty area.



On an uneven or shaky floor.

POWER SUPPLY/GROUND WIRE

1. Use the appropriate power supply. Always connect to AC120V. Unstable voltage may cause electric shock, fire, or damage to the machine. Always avoid using multiple outlet connections.

2. Pay attention to the amperage. Unless the amperage is enough, it may cause fire or malfunction. A dedicated circuit is highly recommended.

3. Ensure a ground connection is correctly made to avoid any danger or electrical problems. Do not alter the power cord.

4. Handle power cord with care.

Do not set the machine on the power cord. Do not pull the power cord forcibly.

Do not place the machine near heated equipment.

Damage to the power cord may cause fire, electric shock or damage to the machine and the operator.

DryLam Publications

23220 W. 84th St., Shawnee, KS 66227

Phone: (888) 633-1973

Brian Jennett- Tech-Line/Service Manager ext 8575

www.DryLam.com



GENERAL CAUTIONS

Always follow these instructions for safe operation.

1. What to wear

In order to avoid any possible danger

- Do not wear neck-ties or necklaces that are loose.
- Do not wear loose clothes. If entangled, turn off the power or unplug immediately.
- Be careful that your hair does not get caught in the machine.

2. Operation

- Always close the covers.
- When you are in a closed room, ventilate well.
- Do not spill water on the machine or handle it with wet hands.
- Do not leave the machine during operation. The socket outlet should be installed near the equipment and be easily accessible.

3. in an emergency

- If a malfunction occurs switch off and/or unplug immediately.
- Contact your dealer or the DryLam Tech-Line for assistance.
- Do not attempt to disassemble/repair /alter the machine yourself without authorization.

4. Others

In order to avoid serious personal injury or damage to the machine:

- Do not use the machine for any other purposes than what it was designed for.
- Do not put heavy items on the machine or subject it to physical abuse.
- Always unplug the machine before moving it.
- Remember that the laminated objects can be very hot.
- Machine may be damaged when incorrectly used.
- Do not drop metal items such as paper clips or staples inside the machine.
- Do not remove the covers from the machine or otherwise defeat the safety switches.
- Never alter or modify the machine.
- Do not remove caution labels from the machine.
- Always use our exclusive AL-ROLL lamination film.

DryLam Publications

23220 W. 84th St., Shawnee, KS 66227

Phone: (888) 633-1973

Brian Jennett- Tech-Line/Service Manager ext 8575

www.DryLam.com



REQUIREMENTS OF PAPER TO BE LAMINATED

Do not laminate:

- Money or valuable securities.
- Paper with staples.
- Magnets or magnetic documents.
- Flammable paper or material that is affected by heat such as vinyl chloride or polyethylene.
- Unique and irreplaceable documents.
- Paper thicker than 0.4mm including film thickness.
- Paper that discolors and changes in quality with heat such as thermal papers and crayoned pictures.
- Paper that contains a lot of moisture.
- Items other than paper (magnets, vinyl, etc.)
- Paper that is curved or has creases.



CLEANING OF EXTERIOR

Be sure that the machine is unplugged.

Before cleaning the machine turn off the power and let the machine cool down.

Wipe off stains with a soft cloth. When stains are persistent use a firmly squeezed soft cloth soaked in a small quantity of water or detergent. Wipe off the residue of detergent with a cloth soaked in water.



USEFUL INFORMATION – FILM END

This model has a function that gives caution that the film will end soon. The final few feet of film has either black colored film or the black colored tape on the film. Please note when doing continuous lamination, that one or two sheets may be laminated with the black tape when film runs out. Therefore, in order to avoid this problem, please check the remaining film amount on the display from time to time. It is recommended to provide extra prints when laminating.

RECYCLING INFORMATION

This is a serviceable electronic device which contains components which should be replaced at the end of their effective lives. You can help control emerging risks by disposing of the electronic device separately from your domestic waste. Electric and electronic devices marked with a crossed out waste bin indicate that these products should not be disposed of together with domestic waste as there may be a severe impact on the environment as well as human health due to the possibly of hazardous materials.

DryLam Publications

23220 W. 84th St., Shawnee, KS 66227

Phone: (888) 633-1973

Brian Jennett- Tech-Line/Service Manager ext 8575

www.DryLam.com

INCLUDED COMPONENTS

Please check all these components are included.

- ALM3230
- Feeder Tray
- Feeder Tray Extension
- Exit Tray
- Power Cord
- Waste Collection Box (in two parts)

DryLam Publications

23220 W. 84th St., Shawnee, KS 66227

Phone: (888) 633-1973

Brian Jennett- Tech-Line/Service Manager ext 8575

www.DryLam.com

2. NAMES AND FUNCTIONS

2-1. EXTERIOR

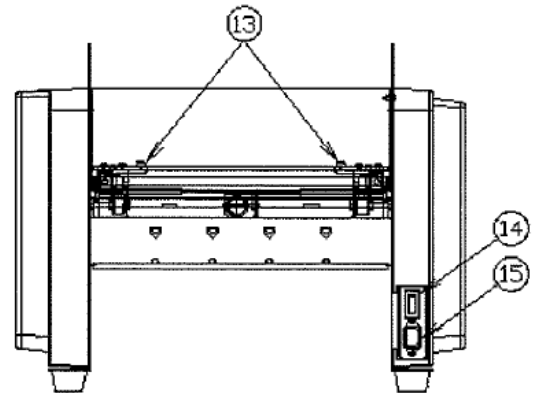
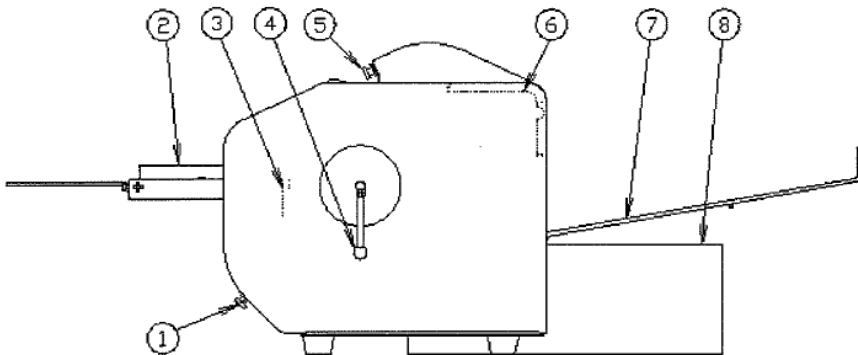
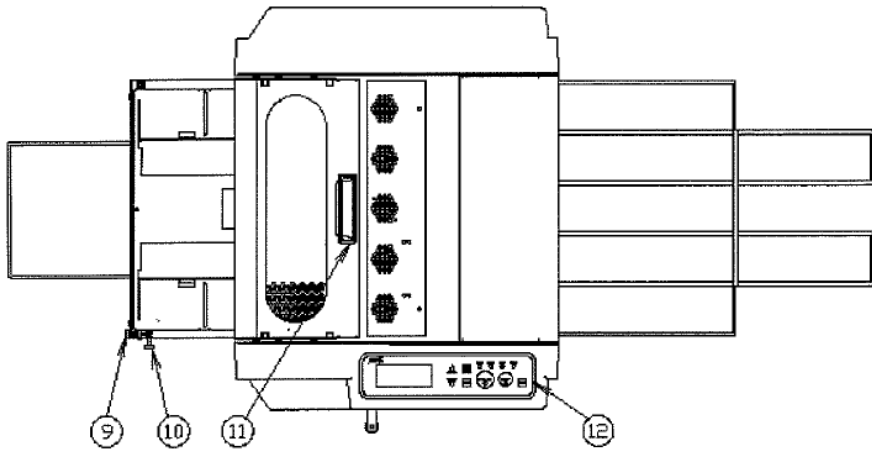

1	Lower Tension Controller	9	Skew Control Knob
2	Feeder Tray	10	Feeding Control Knob
3	Paper Feed Adjust	11	Feeder Release Handle
4	Lamination Handle	12	Operation Panel
5	Upper Tension Controller	13	Trimmer Adjustment Knobs
6	Trimmer Cover	14	Power Switch
7	Exit Tray		
8	Waste Collection Box		

DryLam Publications

23220 W. 84th St., Shawnee, KS 66227

Phone: (888) 633-1973

Brian Jennett- Tech-Line/Service Manager ext 8575

www.DryLam.com

2. NAMES AND FUNCTION (cont'd)

2-2. INTERIOR

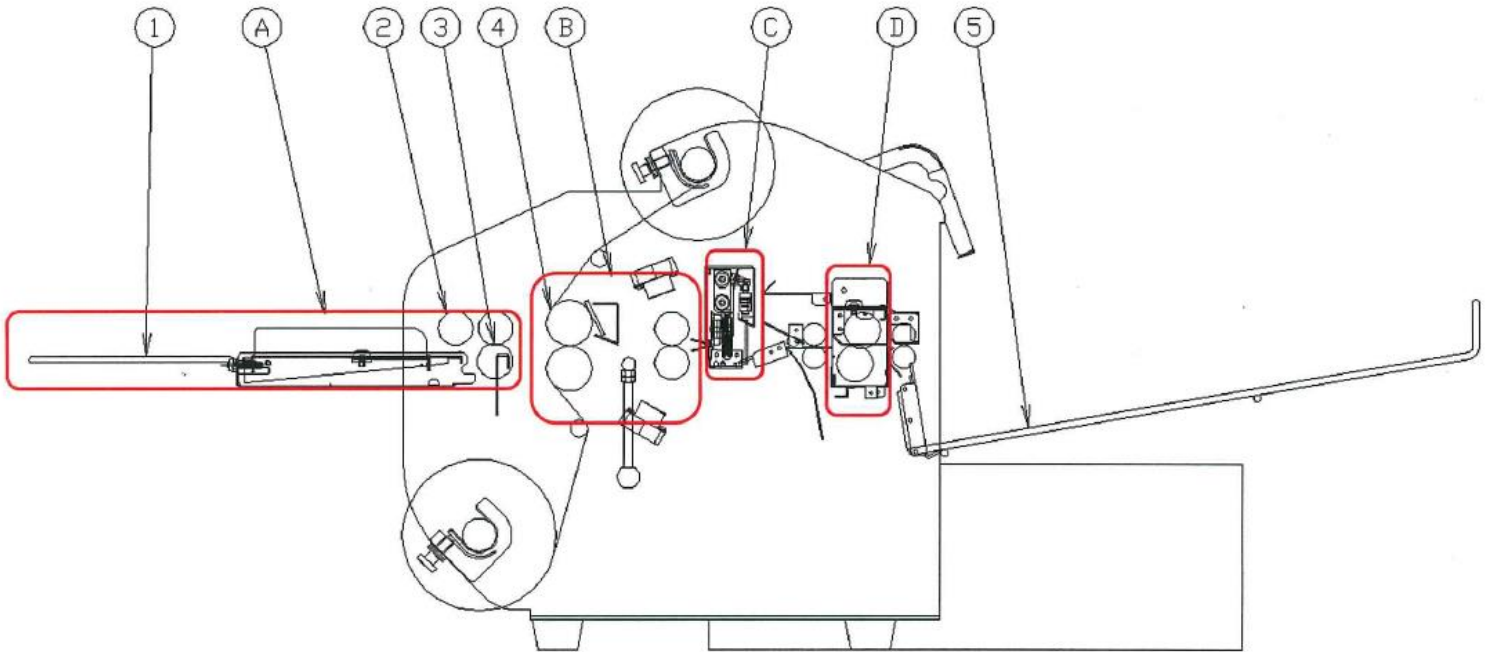

	SECTIONS	FUNCTION
A	Feeder Section	
B	Lamination Section	
C	Cutter Section	
D	Trimmer Section	
	COMPONENTS	
1	Feeder Tray Extension	For longer double letter and digital paper size laminations.
2	Feeder Tray	Tray for letter size paper.
3	Feeder Roller	Picks paper from feeder tray and feeds it to the lamination section.
4	Paper Feed "Resist" Roller	Prevents multiple sheets from entering lamination section.
5	Heat Rollers	Laminates upper and lower film to paper with heat and pressure.
6	Cutter Unit	Cuts front and back of the film (leading and trailing edges).
7	Trimmer Unit	Cuts sides of paper (operator and non-operator sides of the machine).
8	Exit Tray	Tray for finished paper.

DryLam Publications

23220 W. 84th St., Shawnee, KS 66227

Phone: (888) 633-1973









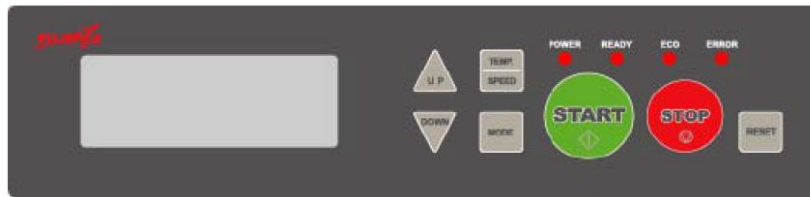



Brian Jennett- Tech-Line/Service Manager ext 8575

www.DryLam.com

2. NAMES AND FUNCTION (cont'd)

2-3. OPERATION PANEL



	START	Press to start operation.
	STOP	Press to stop operation.
	RESET	Press to return to the operation mode and to reset the counter.
	SCROLL (UP)	Press to raise cursor or the set value.
	SCROLL (DOWN)	Press to lower cursor or the set value.
	MODE	Press to select MODE (menus) setting.
	TEMP/SPEED	Press to select temperature or speed setting menus. Hold continuously to see the current temperature.
POWER 	POWER LAMP	Indicates the power is on.
READY 	READY LAMP	Indicates that the set temperature has been achieved.
ECO 	ECO LAMP	Lights during power saving mode.
ERROR 	ERROR LAMP	Lights when an operation error occurs. To aid in servicing note the error message that is generated on the LCD display.
	LCD DISPLAY	Shows status of settings, operation and errors.

DryLam Publications

23220 W. 84th St., Shawnee, KS 66227

Phone: (888) 633-1973

Brian Jennett- Tech-Line/Service Manager ext 8575

www.DryLam.com

2. NAMES AND FUNCTION (cont'd)

2-4. LCD DISPLAY

POWER ON/WARM UP

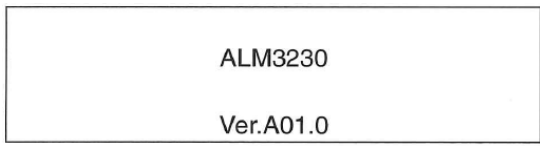

When powered up the LCD will indicate the model and software version.



The next screen will show the type of film, if installed.

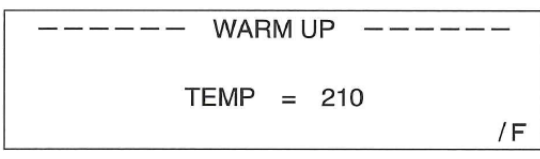

Indicates the machine is being heated up, however operation is not possible during this time.
LCD may indicate "READY" when RFID tag has been damaged or is not in place (see information on film roll RFID tag elsewhere in this manual).

When the ALM3230 reaches set temperature and regulation begins the buzzer beeps three times.

"READY" appears:

- If machine is fully heated.
- Under certain conditions if the RFID tag is not in place and machine is not heated.

If the machine has been properly threaded it is ready to be run in automatic mode. If the machine has **not** been threaded, or if you are unsure that it has been, the START button should NOT be pressed. To set the film and thread the machine see [section 4](#) starting on page 20.

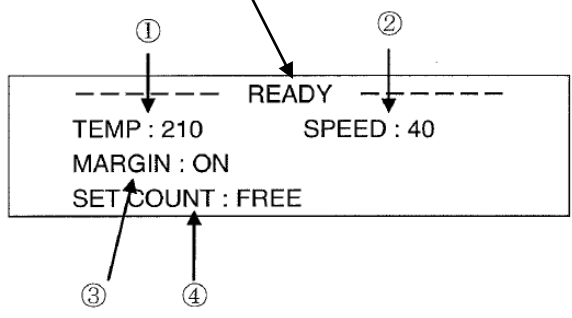

- 1) [TEMP] indicates the set temperature in Fahrenheit. See [section 5-2-1](#) on page 34.
- 2) [SPEED] indicates the set speed in inches per minute. See [section 5-2-2](#) on page 34.

2. NAMES AND FUNCTION (cont'd)

- 3) [MARGIN] indicates that the trimming and cutting is with or without margin of film on the front and back (leading and trailing edges) of the laminated paper. NOTE: A "margin" is a (sealed) edge of film around the laminated paper. See [section 5-2-6](#) on page 40.
- 4) [SET COUNT] indicates number of the papers to be processed. See [section 5-2-5](#) on page 38.

DryLam Publications

23220 W. 84th St., Shawnee, KS 66227

Phone: (888) 633-1973

Brian Jennett- Tech-Line/Service Manager ext 8575

www.DryLam.com

2. NAMES AND FUNCTIONS (cont'd)

2-5. OTHER SWITCHES AND BUTTONS

Open the trimmer cover.

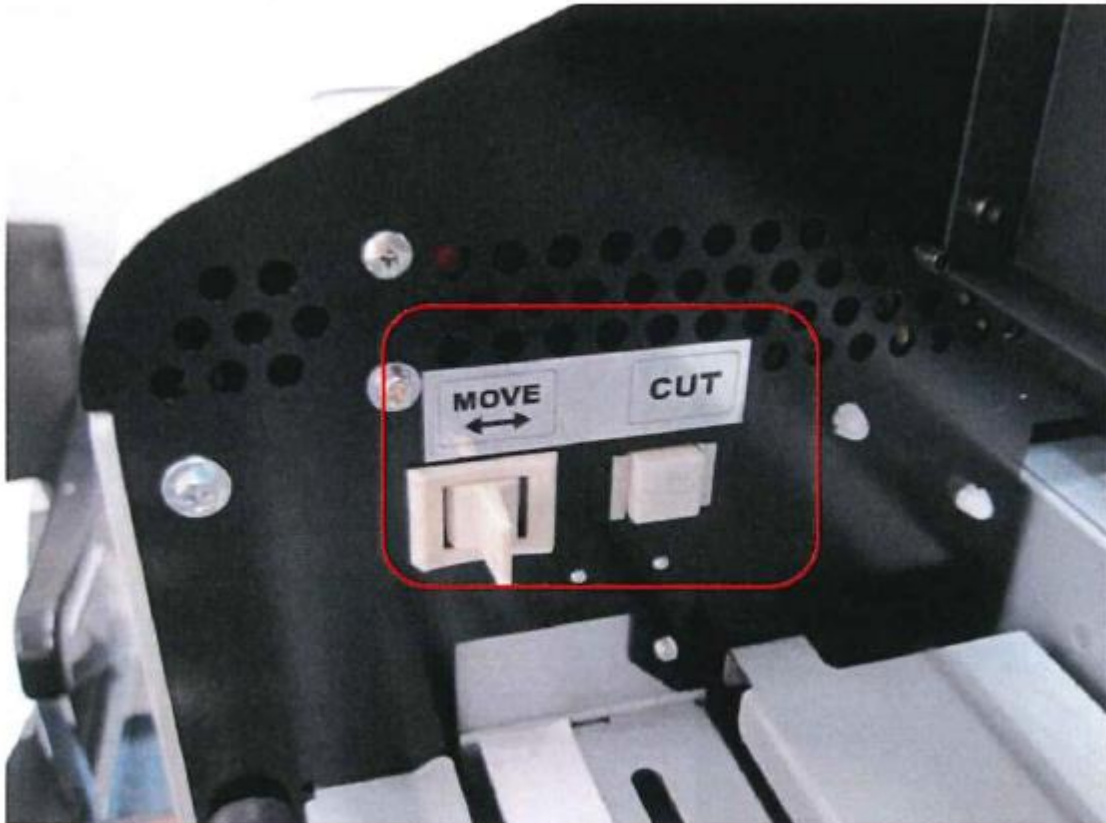

1) Manual MOVE Switch

Use to set/feed film or to take out paper when it is stuck

To feed forward, turn the switch to left.

To feed backward, turn the switch to right.

* Set the trimmer adjuster to Film Set position during the threading process.

The MOVE switch will not operate after some errors (See [#7. TROUBLESHOOTING/ERROR MESSAGES](#)).

2) Manual CUT Switch

Use when setting film or cutting film which is stuck in the laminator. *It does not work when a cutting error has occurred.

DryLam Publications

23220 W. 84th St., Shawnee, KS 66227

Phone: (888) 633-1973

Brian Jennett- Tech-Line/Service Manager ext 8575

www.DryLam.com

2. NAMES AND FUNCTION (cont'd)

NOTE: The manual MOVE switch works most any time during manual mode. Some errors it may be necessary to press RESET to clear the error which will then restore the MOVE switch function.

Other errors (often accompanied by the words "CALL FOR SERVICE") require the ALM3230 to be powered off and turned on again to restore operation.

CAUTION: Whenever using the MOVE switch it is important to account for all film going into the machine, particularly during the threading process. If film does not exit the discharge in less than 5 seconds **STOP!** Film may be accumulating within the machine. If this is allowed to continue, damage to interior components of the machine will occur.

*If you believe an excess amount of film has gone into the machine release the MOVE switch. Raise the Lamination Handle and pull the film back out the front of the lamination area. Use the MOVE switch to assist, if necessary.

*Whenever you use the manual MOVE Switch, even for a brief moment, always move enough film out the discharge to grab on to. Then, always cut the film by using the manual CUT button and pull the cut film/paper from the discharge. This must be performed before pressing the START button, otherwise errors and/or damage to the machine may result.

*After the film waste has been pulled from the discharge the machine is ready to be run in automatic mode. Do NOT run the MOVE switch again unless CUT is performed immediately afterward.

DryLam Publications

23220 W. 84th St., Shawnee, KS 66227

Phone: (888) 633-1973

Brian Jennett- Tech-Line/Service Manager ext 8575

www.DryLam.com

3. INSTALLATION

3-1. INSTALLING THE ALM3230

Allow an area about 24" around the machine and trays for operation. *Read the safety instructions about the installation carefully. Always contact the DryLam Tech-Line if there are any questions or concerns during installation.

3-2. SET FEEDER TRAY



Attach the tray by pointing the feeder tray downward.

1)

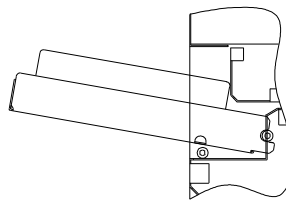

2)

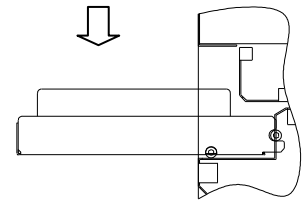

* When you laminate materials in double letter and digital paper sizes set the extension tray on the feeder tray as shown.

3-3. SET EXIT TRAY

Attach the exit tray firmly in the holes. Select upper or lower holes according to the thickness of the finished product.

DryLam Publications

23220 W. 84th St., Shawnee, KS 66227

Phone: (888) 633-1973

Brian Jennett- Tech-Line/Service Manager ext 8575

www.DryLam.com

3. INSTALLATION (cont'd)

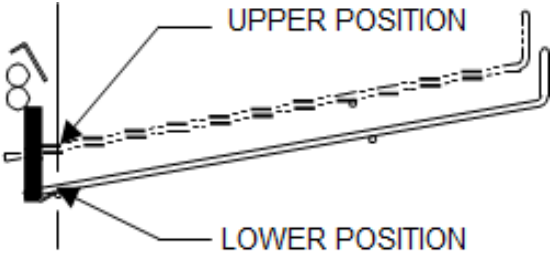

DryLam Publications

23220 W. 84th St., Shawnee, KS 66227

Phone: (888) 633-1973

Brian Jennett- Tech-Line/Service Manager ext 8575

www.DryLam.com

3. INSTALLATION (cont'd)

3-4. SET WASTE COLLECTION BOX

Install the waste collection box just underneath the film waste outlet to collect trimming and cutting scrap.



3-5. CONNECT POWER CORD

Connect power cord to the machine firmly.
Do not turn the power on yet.



23220 W. 84th St., Shawnee, KS 66227

Phone: (888) 633-1973

Brian Jennett- Tech-Line/Service Manager ext 8575

www.DryLam.com

3. INSTALLATION (cont'd)

4. SET LAMINATION FILM/MANUAL MODE

1. AL-ROLL film is the exclusive lamination film for ALM3230. Always use a combined set of upper and lower film together (even if using one-sided film) from the same box. Prior to loading film inspect the rolls for possible shipping damage. **Lower film roll must have a valid RFID tag installed and loaded towards the non-operator side of the machine.**



ATTENTION: If this tag is not in place or it has been damaged the machine will not heat up, or run in automatic mode.



Do not install damaged or “shifted (telescoped)” rolls of film on the ALM3230. These rolls may have been damaged in shipment. The two sheets of film will not overlap each other properly and will causes operational problems.

2. Open the cover at the trimmer. Loosen the black knobs and adjust both the left and right levers to the FILM SET position. Leave this the cover open for the next steps.

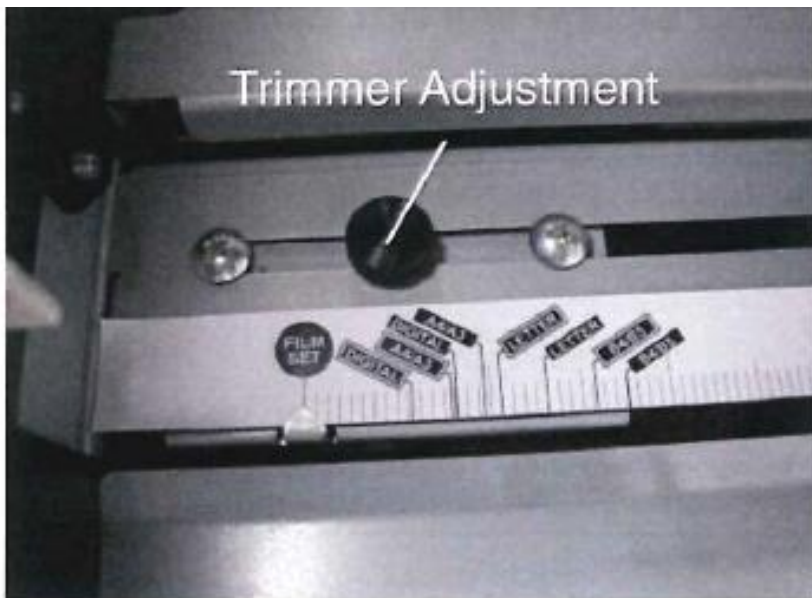

Always make sure that the levers are at the film set position when threading. Otherwise, the threading card will get caught on the trimmer blades. Damage to the trimmer blades and jamming of film may occur.

6227

Brian Jennett- Tech-Line/Service Manager ext 8575

www.DryLam.com

4. SET LAMINATION FILM/MANUAL MODE (cont'd)



3. Open the Feeder Cover and Film Cover.

NOTE: Components on the inside of the machine get very hot. Always be careful.

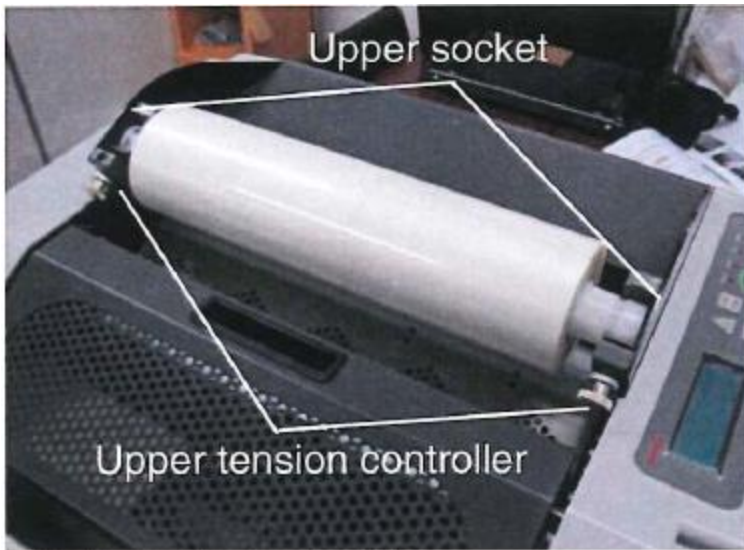

4. Loosen the two tension controllers, if necessary. Set the upper roll of film in the upper mandrel holders. Align the black tape on the film roll with the black dot on the mandrel holder.

DryLam Publications

23220 W. 84th St., Shawnee, KS 66227

Phone: (888) 633-1973

Brian Jennett- Tech-Line/Service Manager ext 8575

www.DryLam.com



4. SET LAMINATION FILM/MANUAL MODE (cont'd)

NOTE: If the film roll(s) are incorrectly loaded adhesive may contact the heat rollers or other interior components and cause damage.



5. Remove the lower Film Guide Bar. Push the bar to one side to compress the spring and pull the other end out of the machine.



6. The lower film roll contains an RFID tag in the left end of the core. Handle this roll carefully! This tag is a printed label adhered to a cap and placed in the end of the core. This cap/tag must be placed carefully towards the non-operator side of the machine.

NOTE: RFID tag location for lower roll

DryLam Publications

23220 W. 84th St., Shawnee, KS 66227

Phone: (888) 633-1973

Brian Jennett- Tech-Line/Service Manager ext 8575

www.DryLam.com

4. SET LAMINATION FILM/MANUAL MODE (cont'd)

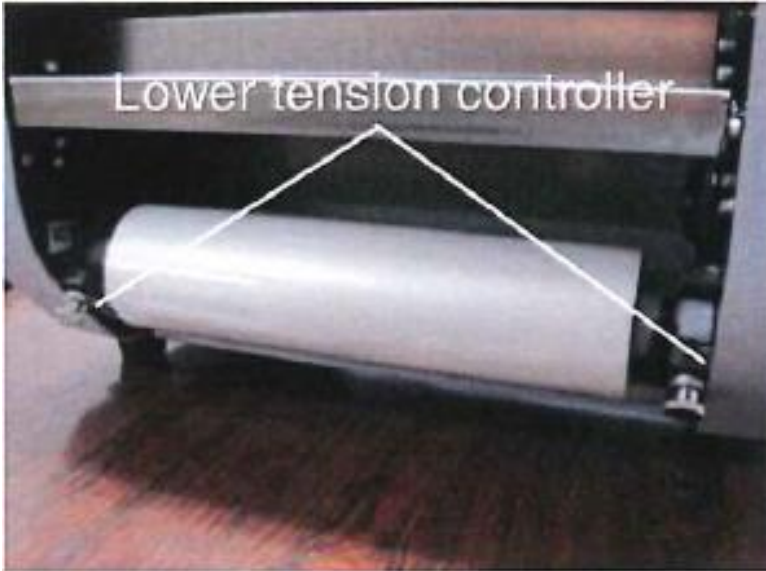

7. Pull about 8-10" of the film off the roll. Loosen the two tension controllers, if necessary. Place the film roll in the lower mandrel holders firmly and carefully (with the RFID tag at the non-operator side). Place the removable rotating idler bar in place. Lay the end of the film back on top of the film roll.

NOTE: If the film roll(s) are incorrectly loaded adhesive may contact the heat rollers or other interior components and cause damage.

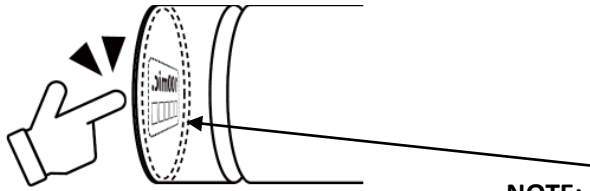

NOTE: RFID tag location for lower roll.

DryLam Publications

23220 W. 84th St., Shawnee, KS 66227

Phone: (888) 633-1973

Brian Jennett- Tech-Line/Service Manager ext 8575

www.DryLam.com

4. SET LAMINATION FILM/MANUAL MODE (cont'd)

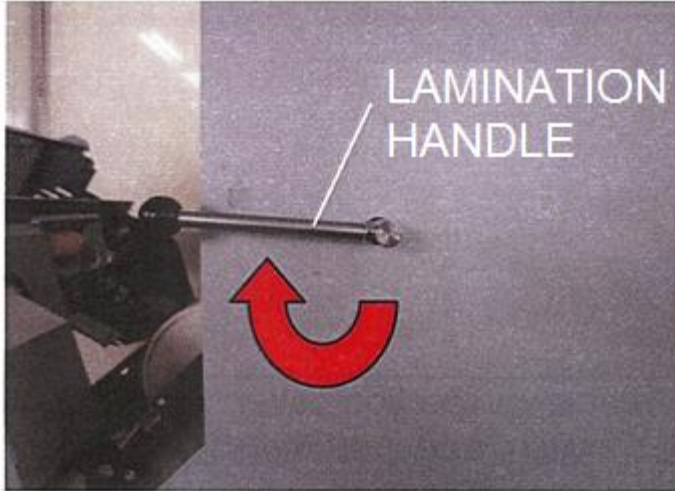

8. Raise the Lamination Handle to the OPEN position to separate the heat and pull rollers for threading.

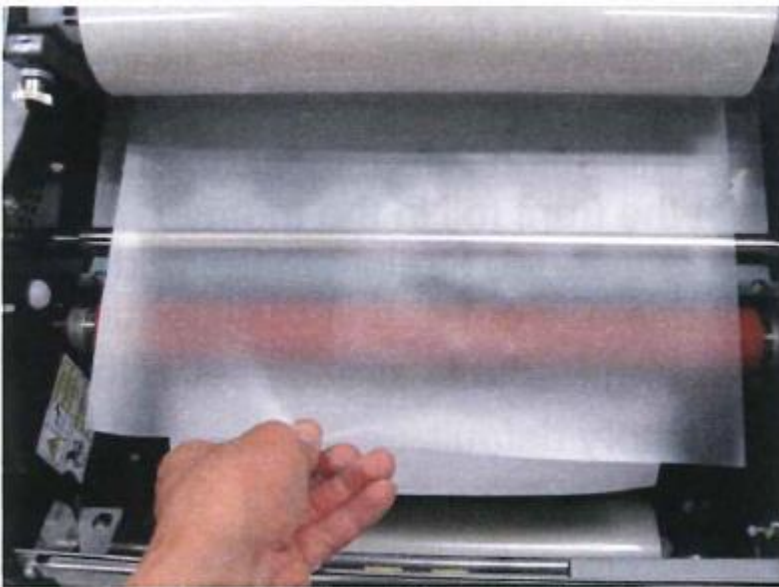

9. Pull the upper film off the roll. Pull it down and **over the upper rotating idler bar**. Bring the end of the film down until it just touches the lower film. This should overlap both heat rollers by a few inches.

10. (Not shown) Bring the lower sheet of film up and over the upper sheet of film. There should now be two sheets of film crossing the heat rollers and overlapping each other by about 6-8”.

DryLam Publications

23220 W. 84th St., Shawnee, KS 66227

Phone: (888) 633-1973

Brian Jennett- Tech-Line/Service Manager ext 8575

www.DryLam.com

4. SET LAMINATION FILM/MANUAL MODE (cont'd)

11. Using an 11" long (by 8.5" wide) threading card (DryLam part number 964202), push both sheets of film between the rollers (and into the 'nip'). Holding the card level continue to push both sheets of film all the way through the machine. There should only be 1" of threading card exposed at the fronts of the rollers at this time.

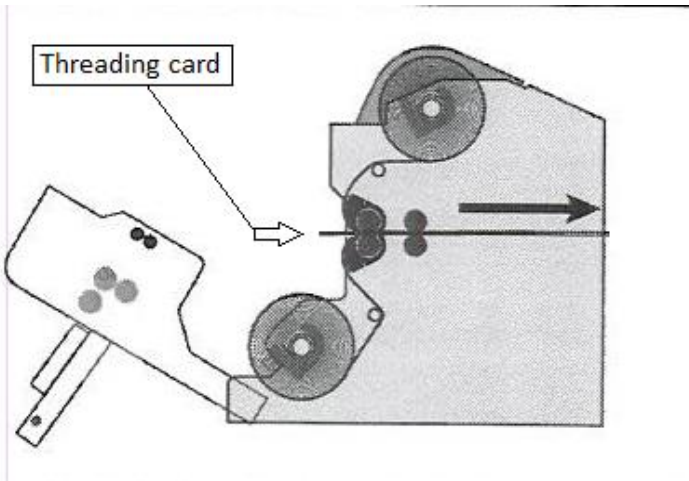

If the threading card will not pass a point about 4" into the machine it is likely being stopped by the film guides on the Cutter Unit. **The threading card MUST pass yet another 4", or so, beyond that point before the lamination handle is lowered** and before the motors are run.

HINTS FOR EASIER THREADING:

- 1) Loosen the tension controllers.
- 2) Turn the film rolls to add "slack" to the film web.
- 3) "Aim" the threading card either up, or down, to allow it to enter the full 11" length. This is extremely important as machine damage may otherwise result if loose film were to "wrap" up or tear off inside the machine, or if the threading card were to be jammed up against interior components of the machine.

12. Do **NOT** lower the Lamination handle at this time.



Applications

23220 W. 84th St., Shawnee, KS 66227

Phone: (888) 633-1973

Brian Jennett- Tech-Line/Service Manager ext 8575

www.DryLam.com

4. SET LAMINATION FILM/MANUAL MODE (cont'd)



13. Turn on the power switch. The heat rollers should begin to get hot. If they do not, check that the **RFID tag is in place on the lower film roll**, that it is **facing the non-operator side** of the machine and was not damaged during the installation.

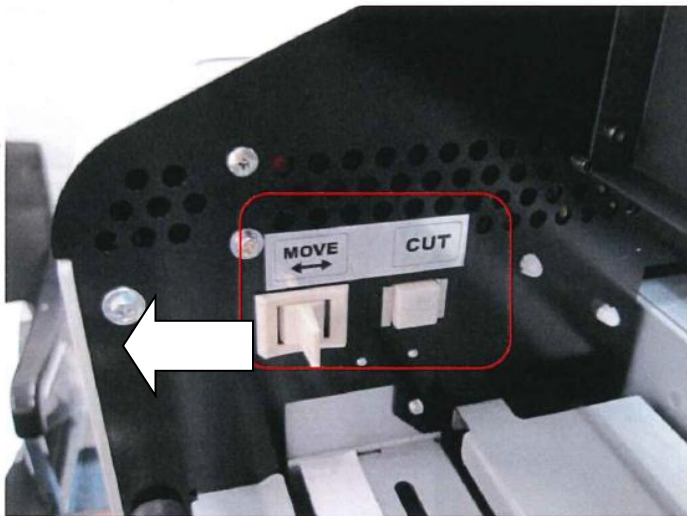

14. Push the Manual MOVE Switch towards the exit of the machine. The threading card and film should start to move. If they do not move **DO NOT LOWER THE LAMINATION HANDLE**. Carefully push the trailing edge of the threading card firmly at the lamination roller area to make the leading edge of the card engage the rollers near the exit. In one or two seconds the threading card, along with two sheets of film should exit the discharge.



If the card and film do not exit the machine within 5 seconds **STOP!** Film could be accumulating within the machine. If this is allowed to continue damage to the machine will occur!

DryLam Publications

23220 W. 84th St., Shawnee, KS 66227

Phone: (888) 633-1973

Brian Jennett- Tech-Line/Service Manager ext 8575

www.DryLam.com

4. SET LAMINATION FILM/MANUAL MODE (cont'd)

If the threading card and film do not emerge from the discharge **within 5 seconds** pull the threading back out of the nip and repeat the threading process from step 6. **If the machine is not threaded properly damage to interior components will occur.**



15. After most of the threading card and film web emerge from the discharge lower the Lamination Handle.

STOP! Do not go any further until the READY light is on AND the machine is fully heated.



16. It is very important to run the machine in "manual mode" (using the MOVE switch) and observe the film as it exits the discharge. It should be well laminated (clear) and free of wrinkles. If wrinkles are observed adjust the tension controller knobs slightly on the film rolls. If the film is curled this could be an indication that the tension of one of the film rolls is tighter than the other. Film must exit the machine flat, clear and free of wrinkles before being put into automatic mode (pressing the START button). If there is curl during manual mode there may be curl during automatic mode which will likely produce errors and possibly damage interior components the machine.

DryLam Publications

23220 W. 84th St., Shawnee, KS 66227

Phone: (888) 633-1973

Brian Jennett- Tech-Line/Service Manager ext 8575

www.DryLam.com

4. SET LAMINATION FILM/MANUAL MODE (cont'd)

17. Adjustment of tension controllers

There are four (4) tension controllers- two for the lower film roll and two for the upper film roll. The purpose of the tension controllers is to apply a resistance, or "drag" on the film rolls which forces the film lay flat on the heat rollers and thereby eliminates creases and bubbles in the lamination.

It is recommended that the right side and left side controllers on each roll be adjusted with the same amount of tension. The top pair of controllers versus the bottom pair of controllers may vary slightly only to eliminate "curl" in the laminated piece. If the laminated piece curls upward loosen the two upper controllers and/or tighten the two bottom controllers. If the exiting laminated piece curls downward, do the opposite and make the lower controllers looser than the upper controllers.

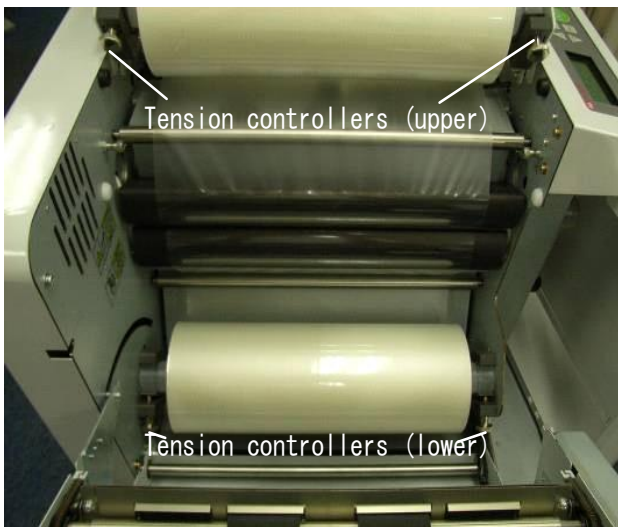

18. Again, after the laminator has "warmed-up" and the READY light is on, use the manual MOVE switch to run film (by itself, no paper) out of the laminator. Observe these samples for clarity and freedom from wrinkles. When all of the bubbles, wrinkles and creases disappear from the lamination and the film is lying flat on the heat rollers the machine is ready to be run in "automatic mode". If lamination defects are not disappearing in a reasonable amount of film footage (3 or 4 feet), slightly increase tension on the controllers (equally). See Step 17.

DryLam Publications

23220 W. 84th St., Shawnee, KS 66227

Phone: (888) 633-1973

Brian Jennett- Tech-Line/Service Manager ext 8575

www.DryLam.com

4. SET LAMINATION FILM/MANUAL MODE (cont'd)



19. Test for film curl. This is important. If film will not exit the machine in a “flat” state there may be jams and wraparounds occurring when the machine is run in “automatic mode”.

If not already done, push the manual MOVE switch forward until about one (1) foot of film has exited the laminator. Then, using a pair of scissors cut the laminated film at a point approximately three (3) inches out from the laminator. Be sure to identify the upper side of the film from the lower side of the film.

NOTE: The laminator is not ready for automatic mode if film is hanging out the discharge (as seen in the photo above). Always press the CUT button and pull the waste of out the machine to ready for automatic mode.

DryLam Publications

23220 W. 84th St., Shawnee, KS 66227

Phone: (888) 633-1973

Brian Jennett- Tech-Line/Service Manager ext 8575

www.DryLam.com

4. SET LAMINATION FILM/MANUAL MODE (cont'd)

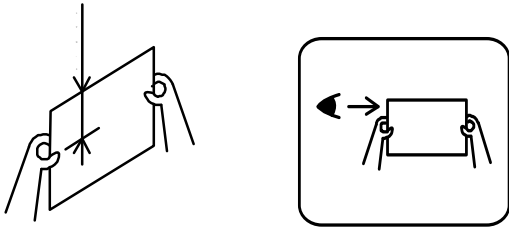

20. Hold the film vertically about 2 inches from the cut side. Look at the film from the side.

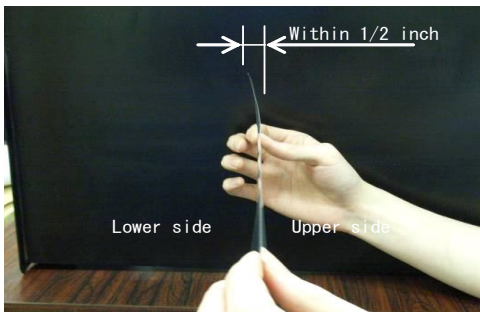

•If the curl is less than 1/2" from the vertical plane, there is no need to adjust.

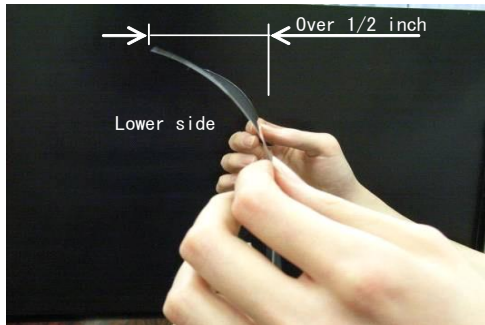

•If the curl is more than 1/2" to the lower side, tighten the two upper tension controllers with half turn.

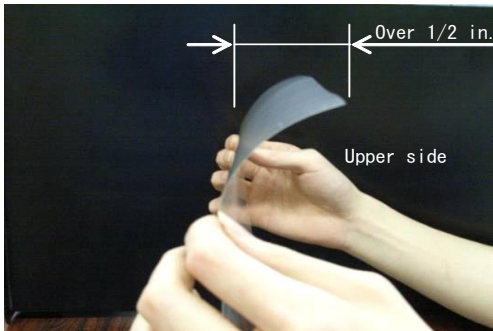

•If the curl is more than 1/2" to the upper side, loosen the two upper tension controllers with half turn.

DryLam Publications

23220 W. 84th St., Shawnee, KS 66227

Phone: (888) 633-1973

Brian Jennett- Tech-Line/Service Manager ext 8575

www.DryLam.com

4. SET LAMINATION FILM/MANUAL MODE (cont'd)

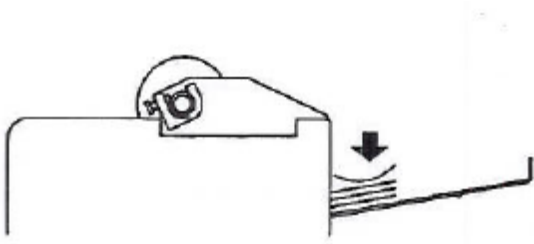

Minimizing the curl may avoid problems as shown below. If film is allowed to curl it will curl up or down into interior areas of the machine. This will result in errors and possible damage to the machine.

The proper tension set with new film rolls will likely be too great as film rolls get smaller with use. Too much tension will result in noise, poor performance and increased wear on the heat rollers. Also, as film rolls reduce in diameter due to use, curling may begin. If curling is allowed to continue film may curl back up inside the ALM3230 and causes jams and wraparounds. If so, re-adjusting the tension controllers may be necessary.

Other results of poor tension controller settings:

A) The corner of the laminated film is folded.

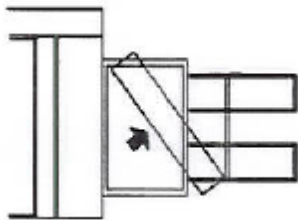
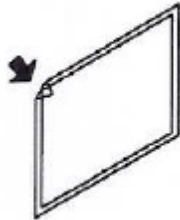

B) Lamination scrap comes out with laminated film.

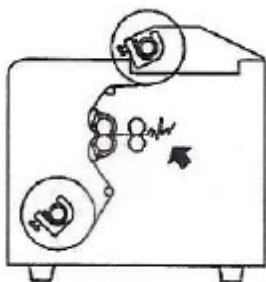

C) Errors appear on the display.

In these cases remove the jammed film.

Follow the trouble shooting procedures of the instruction manual.

DryLam Publications

23220 W. 84th St., Shawnee, KS 66227

Phone: (888) 633-1973

Brian Jennett- Tech-Line/Service Manager ext 8575

www.DryLam.com

4. SET LAMINATION FILM/MANUAL MODE (cont'd)

21. When film is properly overlapped, there are no wrinkles or bubbles, and film exits without curl press the CUT button and pull the waste out of the discharge of the ALM3230.



22. Close the Feeder and Trimmer Covers.

DryLam Publications

23220 W. 84th St., Shawnee, KS 66227

Phone: (888) 633-1973

Brian Jennett- Tech-Line/Service Manager ext 8575

www.DryLam.com

5. AUTOMATIC OPERATION

5-1. WARM UP

CAUTION: Automatic mode should not be performed until the machine has been set up properly in Manual Mode. See page 17 for details.

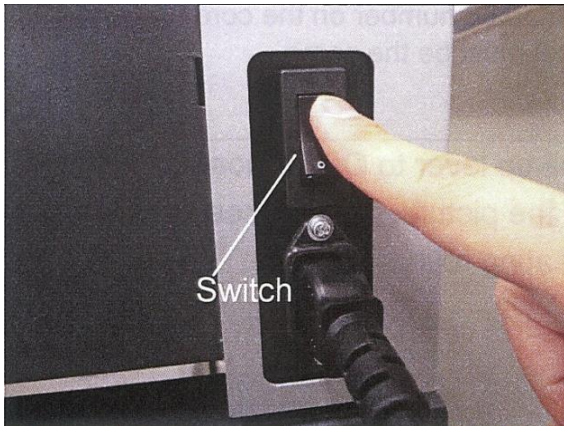

1. Connect the power cord to the wall socket. Turn on the power switch. The POWER lamp lights up.

2. Buzzer beeps.

These displays appear for a few seconds:

```
ALM3230
Ver A01.0
```

Software version appears.

```
-----      FILM INFO      -----
A
38mic.      320mm
LEFT : 80%
```

Film Info display appears. (Or, CHECK FILM error will appear if RFID tag is damaged, or not in place.)

```
-----      WARM UP      -----
TEMP = 210
```

Warm Up display appears.

DryLam Publications

23220 W. 84th St., Shawnee, KS 66227

Phone: (888) 633-1973

Brian Jennett- Tech-Line/Service Manager ext 8575

www.DryLam.com

5. AUTOMATIC OPERATION (cont'd)

5-2. SETTINGS

5-2-1. SET TEMPERATURE

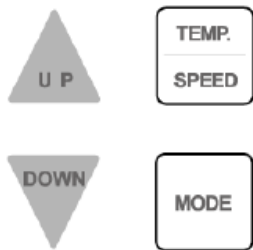

On the "READY" screen press TEMP./SPEED button once.

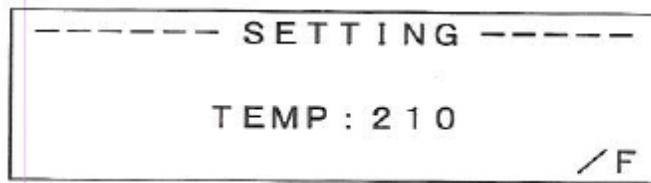

* The default is set at 210F. This is only a power on default and may not be proper for some paper stocks and thicknesses of film.

Press UP or DOWN button to set temperature. Temperature can be set OFF, and between 170F and 270F in 10F increments. The temperature display blinks.

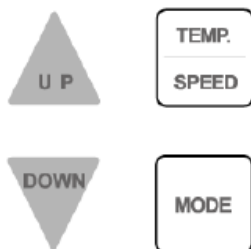

Press TEMP./SPEED button to confirm the temperature.

This table shows an example of temperature settings for different film and paper thicknesses. It also pays to experiment with different temperatures and speeds to achieve quality laminations.

Film thickness	Copying paper	Thicker paper
1.2/1.5mil	210F - 40"/min	220F - 40" /min
3mil	220F - 40" /min	230F - 40" /min
5mil	230F - 40"/min	240F - 40" /min

5-2-2. FIXED SPEED SETTING

Speed is non-adjustable and is set at 40ipm.

DryLam Publications

23220 W. 84th St., Shawnee, KS 66227

Phone: (888) 633-1973

Brian Jennett- Tech-Line/Service Manager ext 8575

www.DryLam.com

5. AUTOMATIC OPERATION (cont'd)

5-2-3. SET TRIMMER MARGINS

CAUTION: Do not adjust the Trimmer Levers or Adjustment Knobs while the machine is running or film is in the Trimmer Unit.

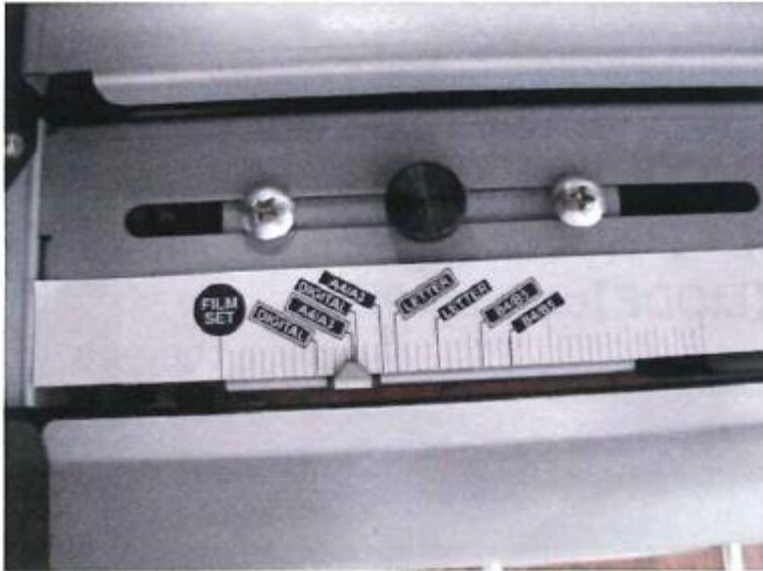

1. Open the trimmer cover.
2. Loosen and adjust both the left and right knobs to set either “with” or “without” margin.
3. Tighten the knobs.

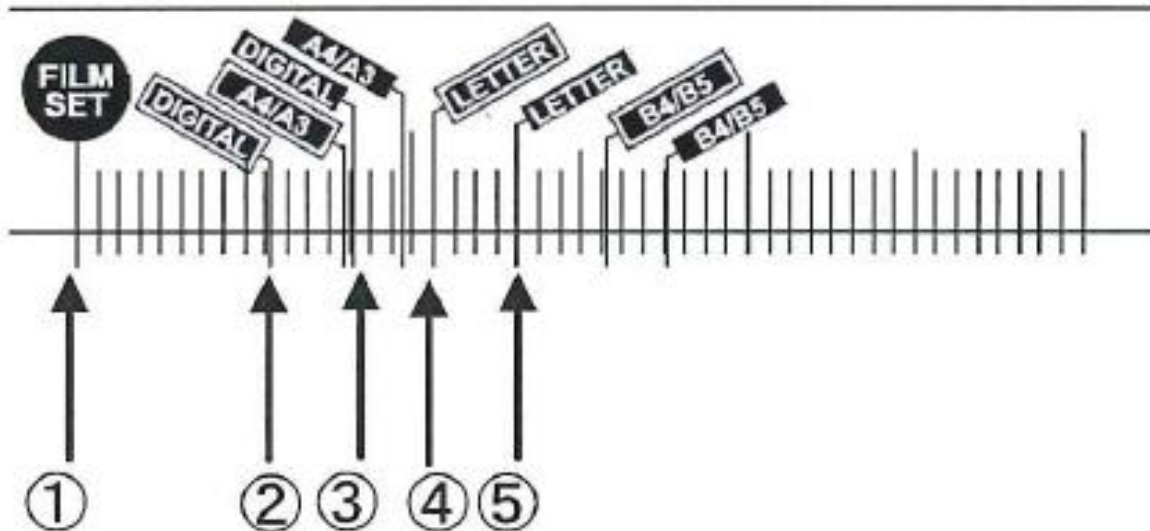

NOTES:

- When setting film, always set the knobs in #1 (Film Set). Otherwise the threading card used for film setting may cause damage to the trimmer blades and will not exit the ALM3230 properly.

DryLam Publications

23220 W. 84th St., Shawnee, KS 66227

Phone: (888) 633-1973

Brian Jennett- Tech-Line/Service Manager ext 8575

www.DryLam.com

5. AUTOMATIC OPERATION (cont'd)

- Do not move the knobs when the ALM3230 is running or when there is film remaining in the trimmer unit.

DryLam Publications

23220 W. 84th St., Shawnee, KS 66227

Phone: (888) 633-1973

Brian Jennett- Tech-Line/Service Manager ext 8575

www.DryLam.com

5. AUTOMATIC OPERATION (cont'd)

5-2-4. MODE MENUS

Press MODE button. The Mode Menu screen will appear:

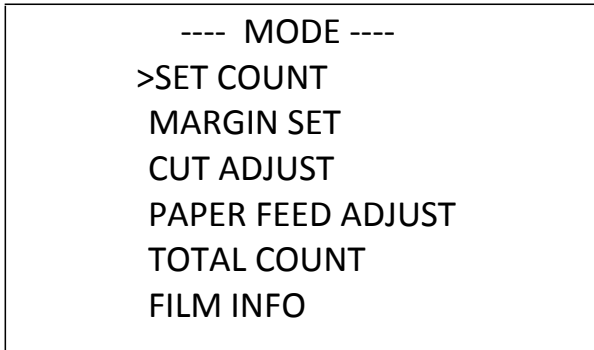

Move cursor to your choice by using UP or DOWN button. Note that some menu choice are below the current screen. Simply cursor down below the last line to view them.



Press MODE button again to view or alter the parameter. Or, do nothing to return to operation screen.



MODE MENU PARAMETERS:

[SET COUNT]

Set the number of sheets you wish to laminate. See [section 5-2-5](#).

NOTE: Defaults to FREE after power outage.

[MARGIN SET]

DryLam Publications

23220 W. 84th St., Shawnee, KS 66227

Phone: (888) 633-1973

Brian Jennett- Tech-Line/Service Manager ext 8575

www.DryLam.com

5. AUTOMATIC OPERATION (cont'd)

Laminate and make cuts either with, or without a margin of film on both the leading and trailing edges of sheets. See [section 5-2-6](#).

NOTE: Defaults to MARGIN: YES after power outage.

[CUT ADJUST]

Adjusts the cutting positions of the leading and trailing edges of sheets. See [section 5-2-7](#).

NOTE: These settings are retained in memory after a power outage.

[PAPER FEED ADJUST]

Works in conjunction with the Paper Feed Resist Roller Pressure Adjust knob (see [section 5-2-12](#)) to provide compatibility for difficult to feed paper stocks and toner. See [section 5-2-9](#).

NOTE: This setting is retained in memory after a power outage.

[TOTAL COUNT]

Total Count indicates the accumulated number of laminations since the RESET button was pushed.

NOTE: This number is retained in memory after a power outage. See [section 5-2-10](#).

[FILM INFO]

Displays information about the film currently in the machine. See [section 5-2-11](#).

NOTE: Information only- nothing to retain.

DryLam Publications

23220 W. 84th St., Shawnee, KS 66227

Phone: (888) 633-1973

Brian Jennett- Tech-Line/Service Manager ext 8575

www.DryLam.com

5. AUTOMATIC OPERATION (cont'd)

5-2-5. SET COUNT

Select SET COUNT.

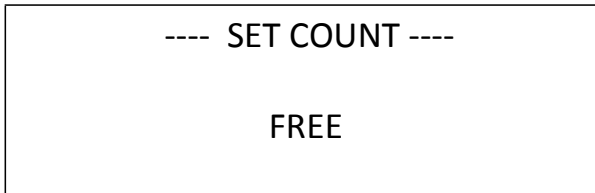

NOTE: Defaults to FREE after power outage.

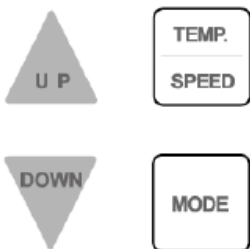

Press UP or DOWN button to enter numeric values. You can set from 1 to 200 sheets.

An unspecified number of laminations is displayed as FREE. The ALM3230 will laminate all sheets on the tray.

Change the value, or do nothing to return to the operation screen.

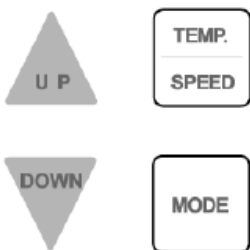

After changing the number do nothing to retain the setting and return to the operation screen. Or, press the MODE button to retain the setting and return to the operation screen quickly.

DryLam Publications

23220 W. 84th St., Shawnee, KS 66227

Phone: (888) 633-1973

Brian Jennett- Tech-Line/Service Manager ext 8575

www.DryLam.com

5. AUTOMATIC OPERATION (cont'd)

Example of setting 100 sheets:

```
---- READY ----  
TEMP: 210      SPEED: 40  
MARGIN: YES  
SET COUNT: 0/100
```

In the above example:

0: finished number/100: set value

NOTE: Lamination errors will not affect the count.

Example of setting FREE:

```
---- READY ----  
TEMP: 210      SPEED: 40  
MARGIN: YES  
SET COUNT: FREE
```

When you select FREE all the papers on the feeder tray will be laminated.

NOTE: A "Feeding Error" will occur after the last sheet has been drawn from the Feed Tray in "FREE" or if the SET COUNT is higher than the number of sheets on the tray. This is normal.

DryLam Publications

23220 W. 84th St., Shawnee, KS 66227

Phone: (888) 633-1973

Brian Jennett- Tech-Line/Service Manager ext 8575

www.DryLam.com

5. AUTOMATIC OPERATION (cont'd)

5-2-6. MARGIN SET

Select MARGIN SET.

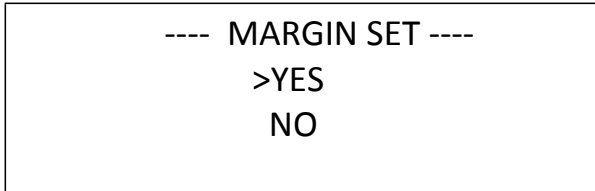

NOTE: Defaults to YES after power outage.

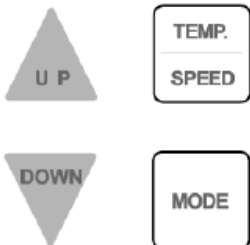

Press UP or DOWN button to turn MARGINS on (YES) or off (NO).

Your choice is retained during this power on session.

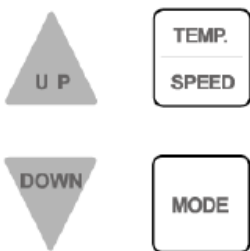

Optional: Press MODE button to return to operation screen.

DryLam Publications

23220 W. 84th St., Shawnee, KS 66227

Phone: (888) 633-1973

Brian Jennett- Tech-Line/Service Manager ext 8575

www.DryLam.com

5. AUTOMATIC OPERATION (cont'd)

5-2-7. CUT ADJUST

This function adjusts the cutting positions at both the leading, and trailing edges of the paper.

NOTE: These settings are retained in memory after a power outage.

NOTE: These settings only affect the leading and trailing edge cuts. They do not affect the side cuts made by the Trimmer Unit.

NOTE: It is recommended to read and record the present values shown on the display before adjusting. It may be helpful if it is necessary to set back to a past value.

NOTE: Each ALM3230 has its own Cut Adjust values. The numbers seen are relative only to this particular machine and not to anything in the "real world".

1. Select Cut Adjust from the Mode display.

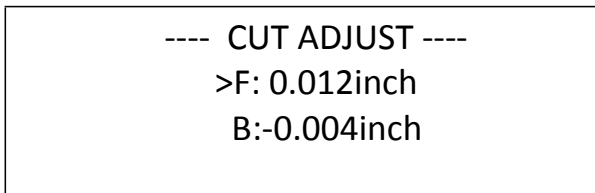

2. Press TEMP/SPEED button to toggle between F and B.



F: cutting position at the front end (leading edge)
B: cutting position at the back end (trailing edge)

Do nothing to return to the operation screen.



3. Or, set one or both values using the UP/Down buttons.



On version 1 adjustment can be done between:
F and B: TBD

Do nothing to retain the settings and return to the operation menu.

DryLam Publications

23220 W. 84th St., Shawnee, KS 66227

Phone: (888) 633-1973

Brian Jennett- Tech-Line/Service Manager ext 8575

www.DryLam.com

5. AUTOMATIC OPERATION (cont'd)

HINT:

The **more positive** (higher) the number the more margin of film around the paper will remain. The maximum margin is approximately ¼".

The **more negative** (lower) the number the closer to the paper cuts will occur (including the possibility of cutting into the paper itself).



4. Or, press MODE button to quickly return to the operation screen.

DryLam Publications

23220 W. 84th St., Shawnee, KS 66227

Phone: (888) 633-1973

Brian Jennett- Tech-Line/Service Manager ext 8575

www.DryLam.com

5. AUTOMATIC OPERATION (cont'd)

5-2-9. PAPER FEED ADJUST (SOFTWARE)

PAPER FEED ADJUST is a parameter that adjusts the aggressiveness of the feeding section to **enhance compatibility of varying paper stocks**. This should be utilized in conjunction with the Paper Feed Resist Roller Pressure Adjust (MECHANICAL) knob under the Feed Tray (see [section 5-2-12](#)).

1. Press MODE and use the arrow buttons to select PAPER FEED ADJUST parameter. Press MODE again.

---- PAPER FEED ADJUST ---- VALUE: 10

2. Adjust the value using the up and down arrows. The factory default is 0. The range is:

Ver 1	+20 to -20 in increments of 1
-------	-------------------------------

If paper/toner is difficult to separate and feed use a more positive (higher) value. This will run the feeder a longer amount of time after the leading edge of paper has passed the Feeder Sensor. Use a more positive value in cases where paper does not reach the film in time (and "LAMINATION ERROR" errors result).

If paper is very easy to separate and feed use a more negative (lower) value. This will make the Feeder **less** aggressive. A lower value should be used if:

- Certain lamination defects occur including, but not limited to, jamming of the leading edge of paper occurs at the film. This might be seen as any, or part of the leading edge of a sheet paper folded over within the film.
- Frequent "PAPER JAM" errors occur.
- Skewing of paper is observed occurring on the paper tray.

DryLam Publications

23220 W. 84th St., Shawnee, KS 66227

Phone: (888) 633-1973

Brian Jennett- Tech-Line/Service Manager ext 8575

www.DryLam.com

5. AUTOMATIC OPERATION (cont'd)

5-2-10. TOTAL COUNT

1. Press MODE and use the cursor buttons to select TOTAL COUNT. Press MODE again.

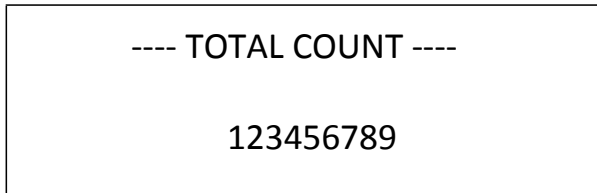

2. Select TOTAL COUNT from MODE menu. The accumulated number of laminations is shown. Counts up to 99999999 until counter is reset.

Do nothing to return to the operation screen. Or, press MODE to quickly return to the operation screen.



OPTIONAL: While on this screen press RESET button to return the counter to "0".

DryLam Publications

23220 W. 84th St., Shawnee, KS 66227

Phone: (888) 633-1973

Brian Jennett- Tech-Line/Service Manager ext 8575

www.DryLam.com

5. AUTOMATIC OPERATION (cont'd)

5-2-11. CHECK FILM INFO

1. Press MODE and use the cursor buttons to select FILM INFO. Press MODE again.

```
---- FILM INFO ----  
A  
38mic.      320mm  
LEFT: 80%
```

This display appears along with the following information:

- Film thickness
- Film width
- Remaining film

If film information is not available the display shows “xxx” rather than numerals:

```
---- FILM INFO ----  
X  
xxmic.      xxxmm  
LEFT: xxx%
```

This will be the case when a valid RFID tag is not in its proper position or an invalid tag is used. See [section 4 for more information on RFID tags.](#)

DryLam Publications

23220 W. 84th St., Shawnee, KS 66227

Phone: (888) 633-1973

Brian Jennett- Tech-Line/Service Manager ext 8575

www.DryLam.com

5. AUTOMATIC OPERATION (cont'd)

5-2-12. PAPER FEED RESIST ROLLER PRESSURE ADJUSTMENT (MECHANICAL)



PROCEDURE:

1. Remove the Paper Feed Resist Roller Pressure Adjust Lever and place it in the appropriate slot of the paper and print being laminated.
2. Always adjust in 1 step increments (or, about one mark at a time on appropriate labels) as follows:
 - a. If too many sheets are being fed at once loosen and slide the knob **downward**.
 - b. If sheets are slow to enter, or will not enter at all (enough that “LAMINATION ERROR”, or other similar errors occur) loosen and slide the knob **upward**.

HINT: Try small adjustments 1 step at a time until the optimum setting is found for the paper stock being laminated. This adjustment should be performed in conjunction with the Paper Feed Adjust (Software) parameter in the menu. [See section 5-2-8](#) for more details.

HINT: When “Lamination Error” and “Feeder Error” appear frequently adjust this knob downward slightly (in small 1/8” increments). For best results use this adjustment along with the Paper Feed Adjust parameter in the Mode Menu.

HINT: This is a compatibility adjustment. There is no “perfect” or “standard” setting. Different paper stocks and toners will have different characteristics. Experimentation is key. It is better to have the

DryLam Publications

23220 W. 84th St., Shawnee, KS 66227

Phone: (888) 633-1973

Brian Jennett- Tech-Line/Service Manager ext 8575

www.DryLam.com

5. AUTOMATIC OPERATION (cont'd)

occasional sheet NOT drawn off the tray (i.e. adjustment lever set too low) than it is to have **too many** sheets drawn from the tray and jamming within the machine (i.e. adjustment lever set too high).

DryLam Publications

23220 W. 84th St., Shawnee, KS 66227

Phone: (888) 633-1973

Brian Jennett- Tech-Line/Service Manager ext 8575

www.DryLam.com

5. AUTOMATIC OPERATION (cont'd)

5-2-13. PAPER SKEW ADJUST



If necessary, correct for paper skewing by adjusting the Paper Skew Adjust knob.

DryLam Publications

23220 W. 84th St., Shawnee, KS 66227

Phone: (888) 633-1973

Brian Jennett- Tech-Line/Service Manager ext 8575

www.DryLam.com

5. AUTOMATIC OPERATION (cont'd)

5-3. SET PAPER

1. Loosen knobs and adjust the paper guides according to paper size. Always use the reference marks and set the paper in the center of the tray



letter size
double letter size



digital paper size



2. Press the edge of the feeder tray downward. Keep pressing it while loading paper.

25220 W. 84th St., Shawnee, KS 66227

Phone: (888) 633-1973

Brian Jennett- Tech-Line/Service Manager ext 8575

www.DryLam.com

5. AUTOMATIC OPERATION (cont'd)

5-3. SET PAPER (cont'd)



3. Place paper in the feeder tray correctly.

* The picture shows how to set letter size.

4. Release your hand from the tray. The spring action will push the paper upwards towards the feeder roller.

Paper is set. Do not push the paper further.

NOTE: It is recommended to place at least 2 sheets of paper.



* If necessary, attach the extension tray for longer paper sizes.

DryLam Publications

23220 W. 84th St., Shawnee, KS 66227

Phone: (888) 633-1973

Brian Jennett- Tech-Line/Service Manager ext 8575

www.DryLam.com

5. AUTOMATIC OPERATION (cont'd)

5-4. START OPERATION

----- READY -----	
TEMP : 210	SPEED : 40
MARGIN : ON	OFF
SET COUNT : FREE	

1. Make sure Lamination Handle is down in the Laminate position.
2. Check the settings.
3. Make sure READY lamp is on.

NOTE: Do not press the START button until the machine has been threaded. See [section 4](#) above on the proper threading process. Otherwise, damage to the machine can occur.



4. Press the START button. Operation starts.

5. Press STOP button during the operation to stop the lamination.



* NOTE: The STOP button is not an emergency stop. Lamination will stop when the process is done.

If emergency stop is required simply open the Feeder, or switch off the power switch.

FILM END

AL-ROLL Film has a special feature that allows the end of the film roll to be detected. The last 20" of each roll of film is colored in black. When this black "leader" passes the Cutter Sensor an error is displayed and operation stops. Remove and discard the partially laminated sheet and install new film.

DryLam Publications

23220 W. 84th St., Shawnee, KS 66227

Phone: (888) 633-1973

Brian Jennett- Tech-Line/Service Manager ext 8575

www.DryLam.com

5. AUTOMATIC OPERATION (cont'd)

5-5. ECO MODE (Power Saving Mode)

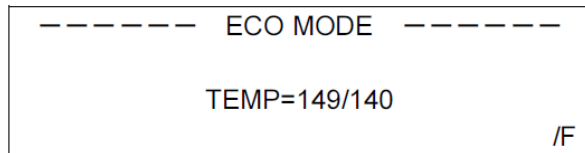

ECO MODE enters when the machine is idle and any buttons on the operation panel* have not been pressed in the past 15 minutes.

*This does not apply to the "MOVE" switch.

A buzzer will sound 1 minute before entering ECO MODE. ECO MODE will be deactivated by pressing any button, the 15 minute timer then starts again.

- 1) Current temperature.
- 2) ECO MODE temperature goal (140F).

5-6. TERMINATE LAMINATION

1. Make sure the lamination has finished.
2. Turn off Power Switch.
3. Disconnect the power plug.

DryLam Publications

23220 W. 84th St., Shawnee, KS 66227

Phone: (888) 633-1973

Brian Jennett- Tech-Line/Service Manager ext 8575

www.DryLam.com

6. LONG MODE

All model ALM3230 auto laminators, regardless of programming version, feature LONG MODE capability. In Long Mode there is no limit to the length of paper that the machine will laminate.

To utilize LONG MODE function, the ALM3230 is started in this manner:

1. Turn the ALM3230 off.
2. Hold the START button.
3. While holding the START button turn the ALM3230 on.
4. After a few seconds LONG MODE will be seen on the LCD.
5. Release the START button.
6. LONG MODE remains active as indicated on the LCD until the machine is shut off and restarted normally.

In LONG MODE leading and trailing edge cuts will always be made according to the size of paper (just like in "Standard Mode" with its 20" paper limit). However, in LONG MODE there is no limit to the length of paper that will be laminated (beyond the 20" standard mode limit).

Some special considerations must be made when working in LONG MODE:

- In the event of a mis-feed or skew operation will continue non-stop. Therefore, it is **mandatory** that an operator be present at all times to monitor operation. If a malfunction occurs (paper jam, or otherwise) and the operator does not switch off the POWER switch severe damage to the machine could occur.
- In proportion to the length of paper being laminated there is the likelihood that paper will 'skew' within the machine, particularly if an operator is not monitoring paper feed from the tray. This will affect the performance of the Cutter and Trimmer Units and, in the event of significant skewing, damage may occur to the paper being laminated or to the machine.
- Cutting and trimming accuracy will be reduced according to the amount of any skewing.
- There are no alarms/errors in LONG MODE in regards to paper length.
- In LONG MODE, be sure to provide extra prints and test the paper before the actual production begins.

DryLam Publications

23220 W. 84th St., Shawnee, KS 66227

Phone: (888) 633-1973

Brian Jennett- Tech-Line/Service Manager ext 8575

www.DryLam.com

7. TROUBLESHOOTING/ERROR MESSAGES

When the ALM3230 stops operation abnormally an error message will occur on the LCD. Error messages are added to machine programming to aid in troubleshooting. Please note that certain messages are similar to others but can occur for different reasons. Please record any messages that should appear in order to assist your servicer and/or the DryLam Tech-Line provide timely assistance.

Problem	Check if:	Solution
<p>● Laminated sheet is not discharged. On the display: DISCHARGE ERROR or LAMINATION ERROR,</p>	<p>Laminated paper is stuck in the lamination section, the trimmer section and/or the cutter section.</p>	<p>[1] Open the Feeder cover. Cut the upper and lower film just below the guide roll. Turn the lamination handle to OPEN position. Hold the cut film firmly. Pull it out toward you. Press RESET button. When the laminated sheet in the machine cannot be taken out, and/or the problem is not solved, turn off the power and contact your dealer or the DryLam Tech-Line. [2] Check if the film waste is stuck in the trimmer unit. [3] Open both the Trimmer Cover and the Cutter/trimmer Cover. Remove the film waste. The lamination rollers get very hot.</p>
	<p>Some useful tips.</p>	<p>Flatten and ‘ruffle’ the paper stack before lamination. If the laminated film has a curl, adjust the film tension to minimize the curl. Empty the waste collection box periodically. The remaining film waste in the waste collection box may pile up and cause problems around the cutter and trimmer units.</p>
<p>● ”CUTTING ERROR”</p>		<p>Open the dark gray trimmer cover at the rear of the machine. Raise the Cutter/Trimmer cover (aka: upper flap). Observe if film/paper has accumulated the area between the cutter and trimmer units. If so, free it by pulling it up and out the top of the cover. Close the cover, press RESET to clear an error on the LCD and press the Manual Cut Switch. After the film/paper has been cut pull the waste out from the flap. If the error is not solved, please contact your dealer or the DryLam Tech-Line.</p>
<p>● ”FEEDING ERROR”</p>	<p>No paper on the tray to feed.</p>	<p>This error is often caused by SET COUNT set to “FREE” and no paper on the tray. Press RESET to clear the error, place paper on the tray and try again. To eliminate this each time the tray runs out go into MODE SET COUNT and set this number less than or equal to the number of sheets placed on the tray.</p>

DryLam Publications

23220 W. 84th St., Shawnee, KS 66227

Phone: (888) 633-1973

Brian Jennett- Tech-Line/Service Manager ext 8575

www.DryLam.com

	Paper is thick and smooth on its surface. The rollers cannot 'grab' the paper. Less than 2" of paper is being pulled before this error occurs.	Remove the paper. Slightly raise the position of Paper Feed Resist Roller Pressure Adjust Lever by one slot. See section #5-2-12. PAPER FEED RESIST ROLLER PRESSURE ADJUSTMENT (MECHANICAL) Ruffle the sheets on the tray. Press RESET button to clear error and start again.
	Paper guides on the feeder tray are restricting the movement of paper.	Widen Paper Guides slightly by about 1/16" to allow paper to move freely from the feed tray into the feeder. Press RESET button to clear error and try again.
	The surface of Feeding Rollers is not clean.	Remove paper from the feed tray. Open Feeder Cover. Wipe off the gray Feed Rollers (particularly the first roller) with a soft cloth. Press RESET button to clear error and try again.
	Paper is stuck between feeding section and lamination section.	Open Feeder Cover. Remove all the stuck paper. Press RESET button to clear error. CAUTION: The lamination rollers get very hot.
●"PAPER JAM"	Do not confuse with "PAPER STUCK". This is a different error. Film/paper is stuck at Cutter section or Trimmer section.	Follow the instructions for the problem. Laminated sheet is not discharged.
	Paper is longer than 20" (see Specifications section)	Use shorter paper or, place ALM3230 into "LONG MODE" to laminate longer sheets.
	Paper is within spec length but, a second sheet of paper has been pulled in underneath the first sheet of paper that the error occurred on. The second sheet of paper is blocking the feeder sensor.	Reset the stack of paper on the feeder tray. Press RESET to clear the error and start again. Make a small downward adjustment to the Paper Feed Resist Roller Pressure adjust lever (see #5-2-12. PAPER FEED RESIST ROLLER PRESSURE ADJUSTMENT (MECHANICAL)).
	Double cutting, too?	Check Cutter sensor- the red number should read ~330-400 when the laminator is "unthreaded" and the cutter unit is installed properly. Should read about 265-275 with the Cutter Unit removed. Threshold (green number) should be about 48. If cutter installed value is lower than cutter removed value, check film guides on Cutter Unit. Contact DryLam's Tech-Line for details on these service issues.
●"DISCHARGE ERROR"	Film and/or paper is hanging from the discharge while the START button is being pressed.	Before pressing START use the CUT button and pull waste from the discharge. The error may go away on its own, or press RESET to clear the error. Then press START and try again.

DryLam Publications

23220 W. 84th St., Shawnee, KS 66227

Phone: (888) 633-1973

Brian Jennett- Tech-Line/Service Manager ext 8575

www.DryLam.com

	Laminated film has a curl and has either curled UP into the area between the cutter and trimmer units. Or, DOWN into the waste collection box.	[1] Press RESET button. [2] Cut the upper and lower film between heat rollers and film guide bar. Press Manual Feed Switch to BACKWARD. Remove (unthread) the film and any paper that may be in the lamination section. Review “Manual Mode”, above, to identify and adjust the film curl.
		If this error occurs repeatedly contact DryLam’s Tech-Line for assistance.
<p>●“LAMINATION ERROR” (NOTE: While diagnosing this problem/error understand that it is better that the occasional sheet of paper does not enter the feeder rather than several sheets at once).</p>	More than 2” of paper was pulled off the tray (and, past the Feeder Sensor) but did not reach the Cutter Sensor within the programmed amount of time. Paper may, or may not, have reached the film (i.e. lamination section).	Too much resistance on the paper tray or in the feeder section. Try raising the Paper Feed Resist Roller Pressure adjust lever by one slot (see the section #5-2-12. PAPER FEED RESIST ROLLER PRESSURE ADJUSTMENT (MECHANICAL)). Do not raise too far or multiple sheet feeding may occur. Press RESET to clear the error and try again. If this error persists they may be a compatibility issue with the paper stock and/or toner being used.
	Paper is stuck in the Lamination section or the Cutter section.	Follow the instructions above for the problem. Remove the film and laminated sheet in the machine using the MOVE switch with discretion (see warnings about overuse of the MOVE switch). If the error is not solved, switch off the ALM3230 and contact your dealer or the DryLam Tech-Line. CAUTION: The lamination rollers get very hot.
	Lamination scrap is stuck in the trimmer section.	Open Trimmer Cover and the Cutter/Trimmer Cover (aka upper flap). Remove all the lamination scrap. Press RESET button to clear error.
	Lamination handle is in the OPEN (9 o’clock) position.	Place Lamination Handle in LAMINATE position (6 o’clock position). Press RESET button to clear error. Be certain the machine is properly threaded (*) and try again. * If the machine is not properly threaded as per instructions damage to the ALM3230 could result.
	Film rolls have run out.	Load new film rolls and thread as per instructions. CAUTION: The lamination rollers get very hot. Press RESET button to clear error.
	A second sheet of paper was pulled in at least 2” by friction from the actual sheet of paper that the error occurred on. This second sheet covered the Feeder Sensor during the time that the first sheet was processed.	Due to the second sheet covering the feeder sensor the ALM3230 assumed the first sheet was longer than machine specifications allow. This is actually considered to be a “multiple feed”. In this case lower the Paper Feed Resist Roller Pressure Lever to resist the multiple feed (see #5-2-12. PAPER FEED RESIST ROLLER PRESSURE ADJUSTMENT (MECHANICAL)). Press RESET to clear the error and try again.

DryLam Publications

23220 W. 84th St., Shawnee, KS 66227

Phone: (888) 633-1973

Brian Jennett- Tech-Line/Service Manager ext 8575

www.DryLam.com

	If film/paper of any length is seen emerging from the back of the machine after this error:	The threading process may not have been completed (see instructions). To complete: move the film further forward using the MOVE switch until no paper is in the film. Then, press the CUT button and pull the waste from the rear of the machine. See instructions for complete details of this threading process. Press RESET to clear the error and try again.
●“(1-2-3) PAPER STUCK”	Do not confuse with “PAPER JAM”. Paper is stuck in feeder section, cutter (lamination) section or trimmer section. The section where the paper is stuck is indicated as an error number on LCD as follows: 1 - Feeder section 2 - Lamination section 3 - Trimmer section	Open the feeder and cutter/trimmer cover. Remove all the stuck sheets in the machine. Follow the instruction for the problem : ●Laminated sheet is not discharged. Press RESET button to clear error. In case the error is not solved, switch off and contact your dealer or the DryLam Tech-Line.
	Lamination scrap is stuck in trimmer section.	Open cutter/trimmer cover. Remove all the lamination scraps. Press RESET button to clear the error.
●“FILM ERROR”	The RFID tag of the film roll is not being read correctly by the ALM3230. Be certain that the film roll containing the RFID tag is placed correctly in the lower position with the RFID tag to the non-operator side of the machine.	The machine will not heat or operate without a valid RFID tag in place. The tag may be missing or it may have been damaged in shipment or installation. Try a different box of film.
●“COVER OPEN”	This error could be either the Feeder or the Trimmer upper flap and cover.	Close the open cover. Press RESET button to clear the error and try again.
●“OVERHEAT”		Turn off the power. Then turn on the power. The problem will be solved in most cases, If the problem is not solved, contact your dealer or the DryLam Tech-Line.
●“TEMP. SENSOR BREAK”		Turn off the power. Contact your dealer or the DryLam Tech-Line. Do not dismantle.
●“TEMP. SENSOR POSITION”	A sudden drop in roller temperature was detected.	Inspect temperature sensor. Possible wrap around of film on the roller. Or, a build up of debris on the sensor caused it to be moved away from the roller. If the problem occurs frequently, contact your dealer or the DryLam Tech-Line.
●“TEMP. SENSOR SHORT CIRCUIT”		Turn off the power. Contact your dealer or the DryLam Tech-Line. Do not dismantle.
●“LAMI MOTOR ERROR”		Turn off the power. The problem will be solved in most cases. If the problem occurs frequently, contact your dealer or the DryLam Tech-Line.

DryLam Publications

23220 W. 84th St., Shawnee, KS 66227

Phone: (888) 633-1973

Brian Jennett- Tech-Line/Service Manager ext 8575

www.DryLam.com

●Other Errors than the above mentioned.		Switch off and contact your dealer or the DryLam Tech-Line Do not dismantle.
●CUTTER DOES NOT CUT WELL	Lamination scrap is stuck in trimmer section.	Open Cutter/Trimmer Cover. Remove any lamination scrap.
●TRIMMER DOES NOT CUT WELL	Check the Feeder Tray.	Adjust the paper guides and/or the feed adjustment knob (on the feeder tray) so that paper is being inserted in the center of the film area. This will make the scraps from the trimmer equal in size for best results.
	Waste accumulated in the trimmer unit	Remove the trimmer unit and check for scrap in, and around the trimmer unit. Contact DryLam’s Tech-Line for additional assistance, if needed.
●LEFT AND RIGHT MARGIN IS NOT EQUAL	Check if the trimmer adjustment knobs are correctly set.	Adjust the trimmer adjustment knobs.
	Is paper skewed within the film area?	Adjust the skewing knob on the Feed Tray.
●CREASES APPEAR IN LAMINATED FILM	Tension controller(s) not set properly?	Run the machine in “Manual Mode” (use the “MOVE” switch). Run laminated film only out the discharge and check for wrinkles. Adjust tension controllers as necessary to minimize wrinkles and curl.
●COMMUNICATION ERROR	Involves the RFID tag reader/writer. This error is often followed by a number:	<p>20: Time out error 01: Invalid command 02: Specified counter error 03: Received data error 04: Data error 05: RFID write error (ch1) 06: RFID write error (ch2, does not apply to the ALM3230)</p> <p>Be certain that the RFID tag is in place and directly in contact with the non-operator side of the frame. See more about the RFID system elsewhere in this manual. If the problem occurs frequently, contact your dealer or the DryLam Tech-Line.</p>

DryLam Publications

23220 W. 84th St., Shawnee, KS 66227

Phone: (888) 633-1973

Brian Jennett- Tech-Line/Service Manager ext 8575

www.DryLam.com

8. CLEANING THE HEAT ROLLERS

With continuous use the heat rollers will accumulate adhesive and dirt. It is recommended that you periodically inspect them for adhesive build-up.

Suggested solvents are:

Rubbing alcohol (isopropyl 70%, or higher)

Goof-Off®,

Acetone

These products are available locally.

NOTE: Be sure the laminator is cool before cleaning with alcohol.



(end)

DryLam Publications

23220 W. 84th St., Shawnee, KS 66227

Phone: (888) 633-1973

Brian Jennett- Tech-Line/Service Manager ext 8575

www.DryLam.com