

# ***Auto Pro*** **Numbering and Perf/Scoring**

**Count**<sup>™</sup>  
MADE IN USA



Serial Number \_\_\_\_\_

Date \_\_\_\_\_

Page left blank intentionally

# Table of Contents

| Topic                               | PG # |
|-------------------------------------|------|
| INTRODUCTION .....                  | 5    |
| PREFACE.....                        | 5    |
| SPECIFICATIONS.....                 | 5    |
| ELECTRICAL SPECIFICATIONS.....      | 6    |
| SAFETY PROCEDURES .....             | 6    |
| BEFORE USE: .....                   | 6    |
| DURING USE: .....                   | 6    |
| AFTER USE: .....                    | 6    |
| CARE AND MAINTENANCE.....           | 7    |
| BEARINGS/BUSHINGS:.....             | 7    |
| SENSOR EYE: .....                   | 7    |
| ROLLER MAINTENANCE:.....            | 7    |
| NUMBERING HEADS:.....               | 7    |
| REMOVABLE SCREWS: .....             | 7    |
| COMPONENT IDENTIFICATION.....       | 8    |
| SETTING UP YOUR AUTO PRO TOUCH..... | 9    |
| DELIVERY TRAY INSTALLATION .....    | 9    |
| PAPER STOP ASSEMBLIES .....         | 9    |
| MACHINE OPERATION.....              | 10   |
| MAIN POWER .....                    | 10   |
| TOUCH SCREEN CONTROLLER .....       | 11   |
| TOUCH SCREEN OPERATION.....         | 11   |
| COUNT LOGO AND SERVICE ACCESS ..... | 11   |
| PERF MODE.....                      | 12   |
| FEED MODE .....                     | 13   |
| NUMBER MODE.....                    | 13   |
| TRANSPORT OPERATION .....           | 14   |
| PROGRAMMING FOR NUMBER MODE.....    | 15   |
| SAVING NUMBERING JOBS.....          | 16   |
| RECALLING NUMBERING JOBS: .....     | 16   |
| BATCH COUNTER .....                 | 17   |

|  |    |
|--|----|
| FEED TABLE ASSEMBLY.....   | 18 |
| ADJUSTING THE FEED RAILS .....                                     | 19 |
| SQUARING THE FEED RAILS .....                                      | 19 |
| PAPER CALIPER ASSEMBLY COMPONENT IDENTIFICATION .....              | 20 |
| PAPER CALIPER ASSEMBLY HEIGHT ADJUSTMENT FOR PAPER THICKNESS ..... | 21 |
| ADJUSTING THE PAPER SEPARATOR SPRING .....                         | 21 |
| CHANGING THE STATIONARY WHEEL .....                                | 22 |
| LOADING THE FEEDER .....   | 23 |
| FEEDING NOTES.....   | 23 |
| REPLACING FEED WHEELS .....  | 24 |
| CHECKING THE SENSORS .....   | 24 |
| NUMBERING HEAD .....   | 25 |
| NUMBERING HEAD PART NUMBERS: .....                                 | 26 |
| DEPRESSING A WHEEL.....  | 27 |
| CHANGING PRINT ORIENTATION OF THE HEAD.....                        | 27 |
| ADJUSTING THE VERTICAL BRACKET .....                               | 28 |
| ADJUSTING FOR A LEVEL IMPRESSION .....                             | 28 |
| TIPS FOR LEVELING HEAD .....                                       | 29 |
| SETTING THE REPEAT SELECTOR .....                                  | 29 |
| INK CARTRIDGE.....   | 31 |
| PERF SHAFT & STRIKE PLATE .....                                    | 32 |
| REMOVING THE PERF SHAFT .....                                      | 32 |
| PERFORATING AND SCORING ASSEMBLIES.....                            | 33 |
| GRIPPER WHEEL PERF-SCORE MOUNTING.....                             | 34 |

# INTRODUCTION

## PREFACE

The Auto Pro Touch is a precision Pneumatic Numbering, Perforating, and Scoring machine. With its intuitive touchscreen design it can perform up to 12 numbers per page. It has an automatic bottom friction feed that is easy to setup. The bottom feed caliper assembly self-fans the paper for a smooth consistent feed.

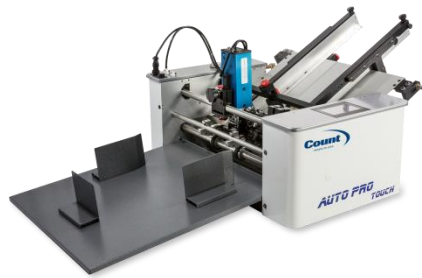
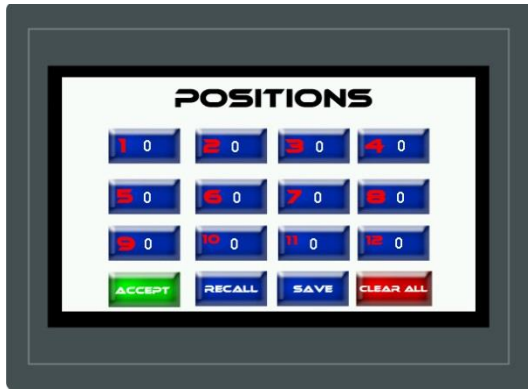

## SPECIFICATIONS

|                                      |   |                                 |
|--------------------------------------|---|---------------------------------|
| Net Weight:                          | .....   | 160 lbs (72.57 kg)              |
| Overall Dimensions:                  | .....L 32in (81.28 cm) x W27in (68.58 cm) x H 26in (66.04 cm)     |                                 |
| Boxed Dimensions:                    | .....W 35 ½in (90 .17 cm) x D 32in (81.28 cm) x H 26in (66.04 cm) |                                 |
| Boxed Weight:                        | .....   | 234 lbs (106.14 kg)             |
| Min. Sheet Size:                     | .....   | 3in (7.62 cm) x 5in (12.7 cm)   |
| Max. Sheet Size:                     | .....   | 18in (45.2 cm) x 20in (50.8 cm) |
| Paper Weight Range: (gsm)            | .....   | 120-350                         |
| Perforating Speed: (sheets per hour) | .....   | 12,000                          |
| Numbering Speed: (sheets per hour)   | .....   | 6,500                           |

## ELECTRICAL SPECIFICATIONS

Power Requirement: 110v/220v, 60/50 HZ, AC 15AMP

Circuit Protection: 3 AMP Circuit Breaker

Air Compressor with Min 60 PSI. (Not Included)

**NOTE: Older buildings, overloaded lines, and bad grounds can affect the operation of your Auto Pro Touch. A regulated dedicated line is recommended. Operating the machine through a power strip is not recommended.**

## SAFETY PROCEDURES

# BE ALERT! BE CAREFUL!

### *BEFORE USE:*

- Read through the owner's manual. Follow instructions CAREFULLY.
- Install the machine on even ground.
- NEVER use in a wet area. Electric shock could occur.
- Use at least a 15 amp power source at 110 v
- Use a GROUNDED outlet and a GROUNDED circuit. Do not use ungrounded equipment on the same circuit.
- Always use a dedicated line. DO NOT use with line splitting surge protector.

### *DURING USE:*

- Exercise caution with long hair, loose fitting clothes when near the machine nip points, while in operation.
- Keep fingers and hands away from belts, numbering heads, perforating blades, and rubber rollers.
- Keep fingers away from any moving part.
- Keep cords clear of moving parts.
- Do not place any liquid on any surface of machine.
- Do not put heavy matter on machine.

### *AFTER USE:*

- Turn off machine at the back panel, then unplug the main power cord. This will prevent damage to your machine by power/voltage spikes.
- To unplug cords, always grasp the plug body, never pull on cords to disconnect. Wire fatigue and possible shock could result from improper disconnect procedures.
- Disconnect the power before cleaning the inner machine.
- Clean all rollers, belts and moving parts.
- Cover the Machine.

## CARE AND MAINTENANCE

The Auto Pro Touch is a precision machine. It is very important to keep it free of excessive dust, dirt and foreign matter. We recommend that you keep the machine **covered** when not in use.

**BEARINGS/BUSHINGS:** The AUTO PRO TOUCH uses 2 different style bearings sealed roller bearing and bronze bushings. Sealed roller bearings are designed to be self lubricating, however dirt and dust can get into them causing clogging and dirt build up. Bronze bushings need to be oiled on a regular basis. The bronze bushings on this machine are located on the feed drive under the feed table and on the small idler pulley's to tension the belts on the non operator side. To oil these bronze bushings run the machine in feed mode and add a few drops of oil just inside the shaft collar that hold the shaft in place. Also add a few drops of light machine oil such as 3-in-ONE (do not use WD40) inside of the machine so both sides of the bushing gets oil. It is recommended to occasionally oil the sealed roller bearings under heavy use.

**SENSOR EYE:** Clean the sensor area on the strike plate so paper dust does not collect and block the sensor. Use a slightly damp cloth to remove any paper dust. A Q-Tip may be necessary to clean and try off the sensor.

**ROLLER MAINTENANCE:** Excess paper dust will cause slippage of the paper. You must clean the rollers regularly to ensure good registration. To do this, unplug the machine carefully, remove the numbering heads, and use a clean wet rag with water only and clean each roller. If you do keep your Auto Pro Touch clean and in top condition, it will give you years of service.

### **NUMBERING HEADS:**

Keep your numbering heads clean with Simple Green and then oil with 3-in-ONE oil. It is suggested to do this **after every use**. To clean: Remove numbering head and place it in a small container with enough solution to just soak the numbering wheels. Stand the head upright so that the solution does not enter into the electronics. Spin each wheel and brush wheels lightly, pat dry or blow dry with a compressor. Do this periodically to insure clean impressions. **DO NOT USE BLANKET WASH!**

**REMOVABLE SCREWS:** When they show signs of wear or stripping, replace as soon as possible. If they strip or hollow out they can be costly to remove. If you do keep your AUTO PRO TOUCH clean and in top condition, it will give you years of service.

## COMPONENT IDENTIFICATION

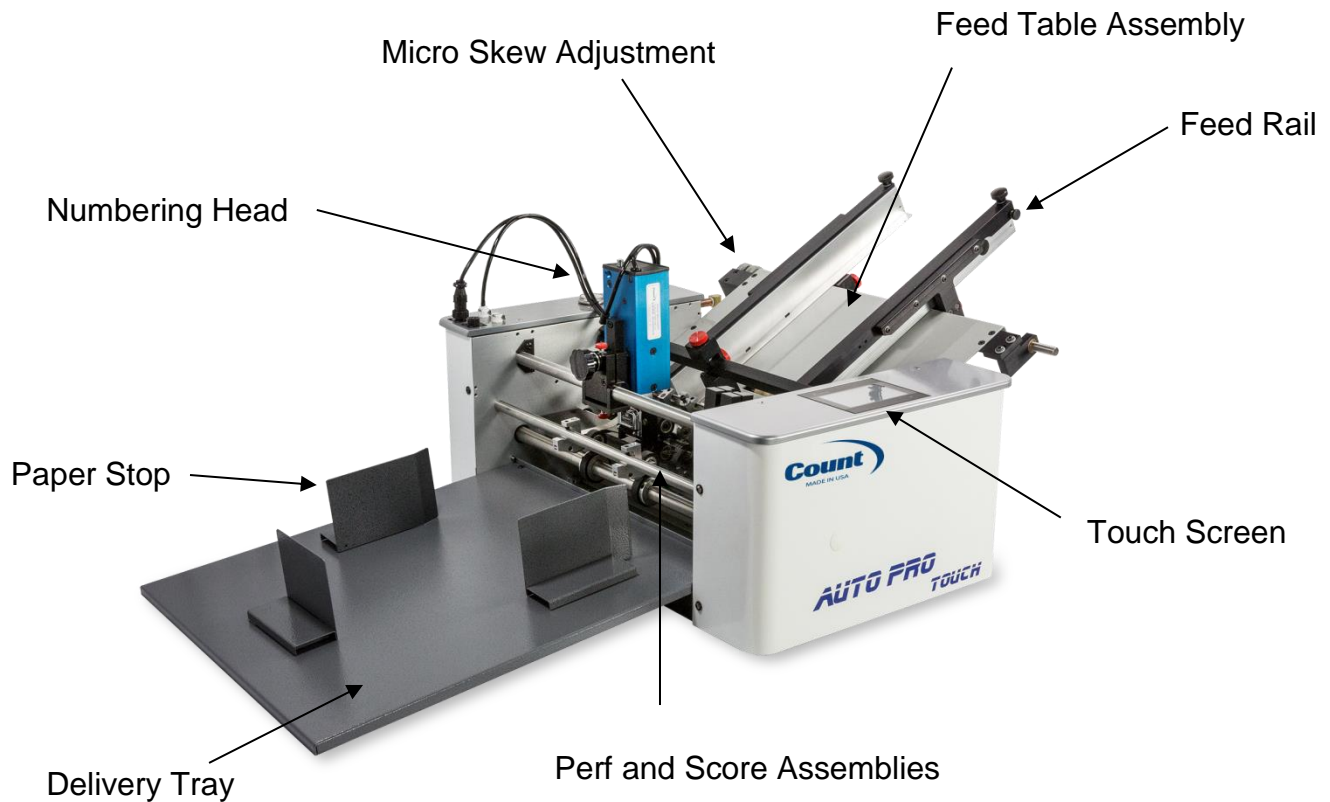

## REFERENCES

|                       |        |
|-----------------------|--------|
| Paper Stop            | Pg. 9  |
| Delivery Tray         | Pg. 9  |
| Touch Screen          | Pg. 11 |
| Feed Rail             | Pg. 18 |
| Feed Table Assembly   | Pg. 18 |
| Micro Skew Adjustment | Pg. 18 |
| Numbering Head        | Pg. 25 |

**Note: We are continuously improving and changing the machine. Specifications and information in this manual are updated as per the change and without any notice.**



## SETTING UP YOUR AUTO PRO TOUCH

1. Open top of crate and remove components.
2. Assemble stand part # CTS100 (If ordered). (See Directions)
3. Place machine on stand or table.
5. Place delivery tray in front so tray hooks under the steel dowels located directly below the exit shaft. Locate the magnetic paper stops and position them on the tray.
6. Inspect the remaining parts and place them near the machine where they are easily accessible.
7. Plug in your machine to any **110-240v outlet**.

### *DELIVERY TRAY INSTALLATION*

The delivery tray is made to fit 2 different configurations depending on if the machine is on a dedicated stand or if the machine is on a table. Position the tray to slide it under the 2 dowel pins and rest the angle stop up.

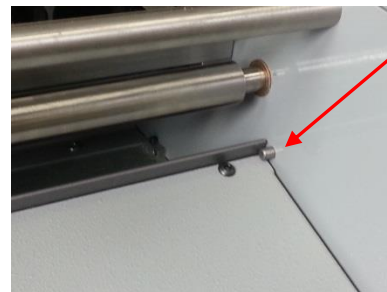

Dowel Pins used to hold delivery tray

### *PAPER STOP ASSEMBLIES*

There are three different paper stops. Two will have a bend and one will be straight. The straight paper stop is the rear or back paper stop. The bent paper stops are for the side paper stops. They hold their position using a magnet which makes it easy for adjustment. The positions for the paper stops will change for each individual job. If the paper stops are set too close the paper will hit them as it exits the machine and will cause a paper jam. If they are set too loose the paper will stack in an unorganized manner. Getting the position correct is imperative to smooth operation of the machine.

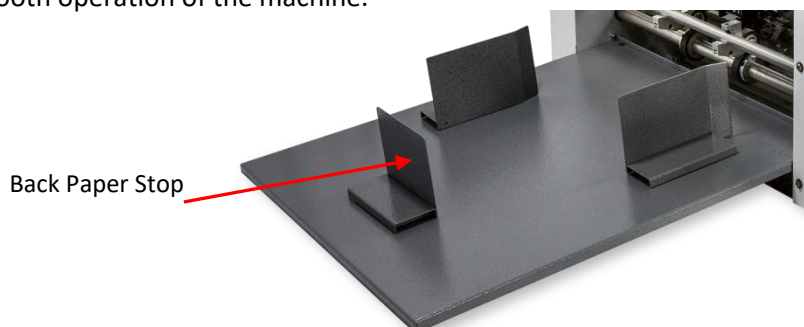

## MACHINE OPERATION

### *MAIN POWER*

On the rear panel of the machine under the feed table is the main power switch. This is the on and off power for the entire machine. When switched on the touchscreen will turn on, this is how you know the machine is on. **Do not leave the machine on when not in use.**



## TOUCH SCREEN CONTROLLER

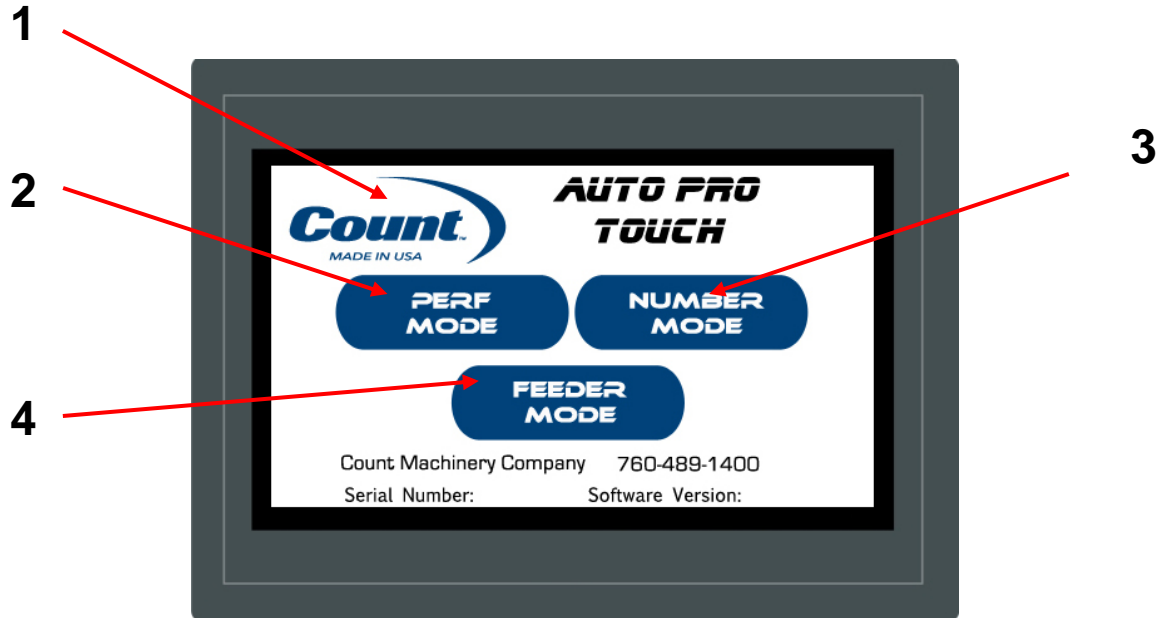

### THE TOUCH SCREEN CONSISTS OF FOUR SECTIONS:

1. Count Logo and Service Access
2. Perf Mode
3. Number Mode
4. Feeder Mode

### *TOUCH SCREEN OPERATION*

When the machine is turned on the display may take up to 7 seconds for the home screen to display. There is a screen saver that will turn the display off if the machine is not touched within 30 minutes. The power light will stay illuminated letting you know the machine is still on.

### *COUNT LOGO AND SERVICE ACCESS*

If the logo is pressed a password screen is displayed. This is for factory and service access only. This screen is for manufacturer use only. The password is not given out.

## PERF MODE

From the home screen, press the perf mode button the perf mode screen will be displayed

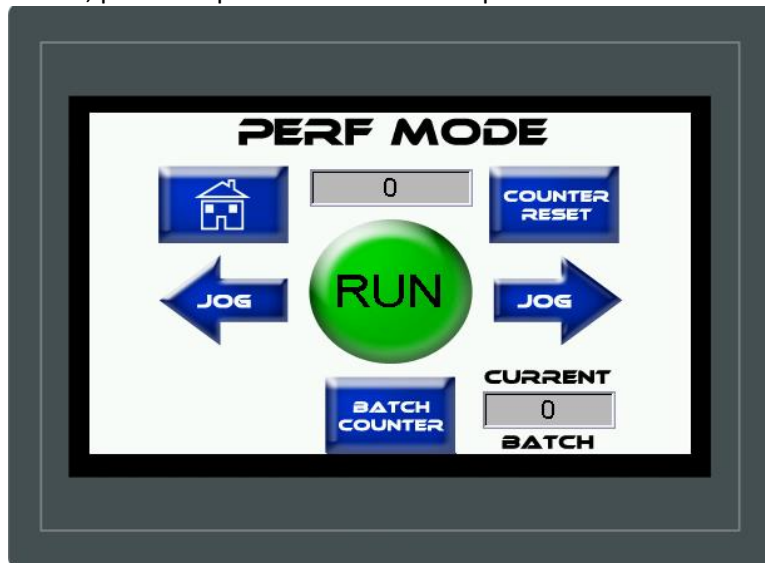

Home: Takes you back to the home screen.

Counter Reset: Resets the displayed counter to 0.

Jog Left and Right: Slowly advances the rollers forward or backward.

Batch Counter: Allows for stopping the machine after a batch number is reached.

Run: Turns on the transport and starts the feeding of paper

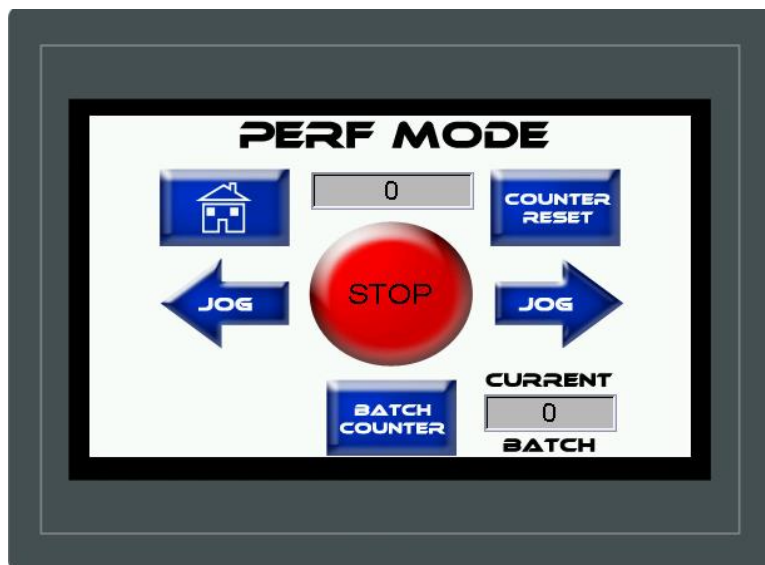

When the Run Button is pressed, the graphic will change red and the button will flash. This is the indicator the machine is running.

## ***FEED MODE***

Feed mode is the mode to run your AUTO PRO TOUCH as a feeder into other types of finishing equipment. Ex. Laminators folders, staplers. etc.

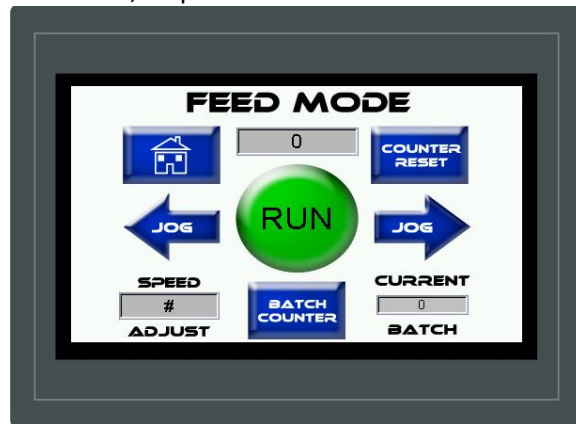

Home: Takes you back to the home screen.

Counter Reset: Resets the displayed counter to 0.

Jog Left and Right: Slowly advances the rollers left or right.

Batch Counter: Allows for stopping the machine after a batch number is reached.

Run: Turns on the transport and starts the feeding of paper.

Speed Adjust: Adjusts the speed in feeder mode from 1000-9999

## ***NUMBER MODE***

Number mode is used to apply a numbering impression to a piece of paper. In this mode, enter the positions and what number head you would like to use for that position.

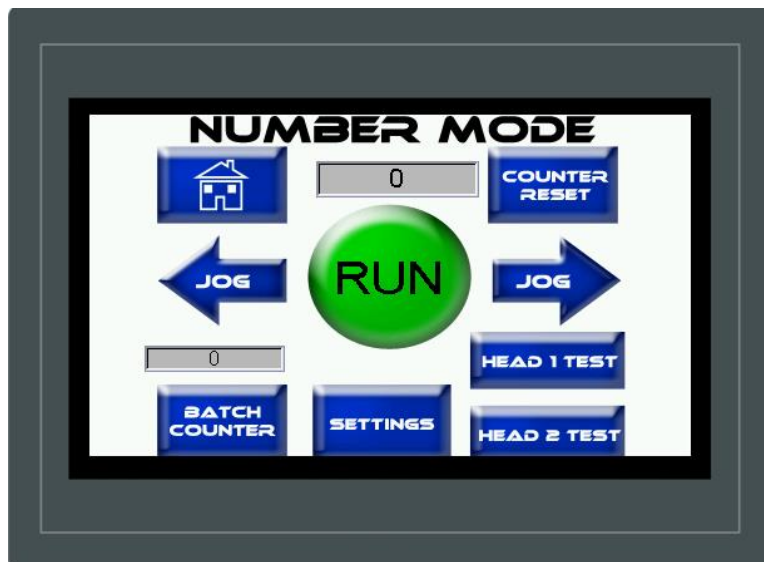

## TRANSPORT OPERATION



- The Run Button will start the transport motor in any given mode. Press it again to stop the transport. Each Mode has a timeout feature to preserve the life of the machine.
- A document may be slowly advanced through the transport by pushing and holding one of these buttons.

**EXAMPLE:**



The motor should advance transport at slow speed and stop whenever your finger is lifted.

- Controls on-off function of motor.

**EXAMPLE:**



Machine will run at mode and speed previously selected.

- Machine will stop.



# PROGRAMMING FOR NUMBER MODE

In Numbering Mode it is important to understand how to program the positions. The machine must be programmed using the lead edge as reference. What this means is the position 2 cannot be before position 1. The distances of the program must be from the low to high stating with the lead edge. Each Position can fire Head 1, Head 2, or Both.

Press the Number Mode Button > Positions > 1 Position > Enter in Position in mm > Select Head 1, 2, or Both > Accept > Run.

Repeat for each desired numbering position.

## EXAMPLE:

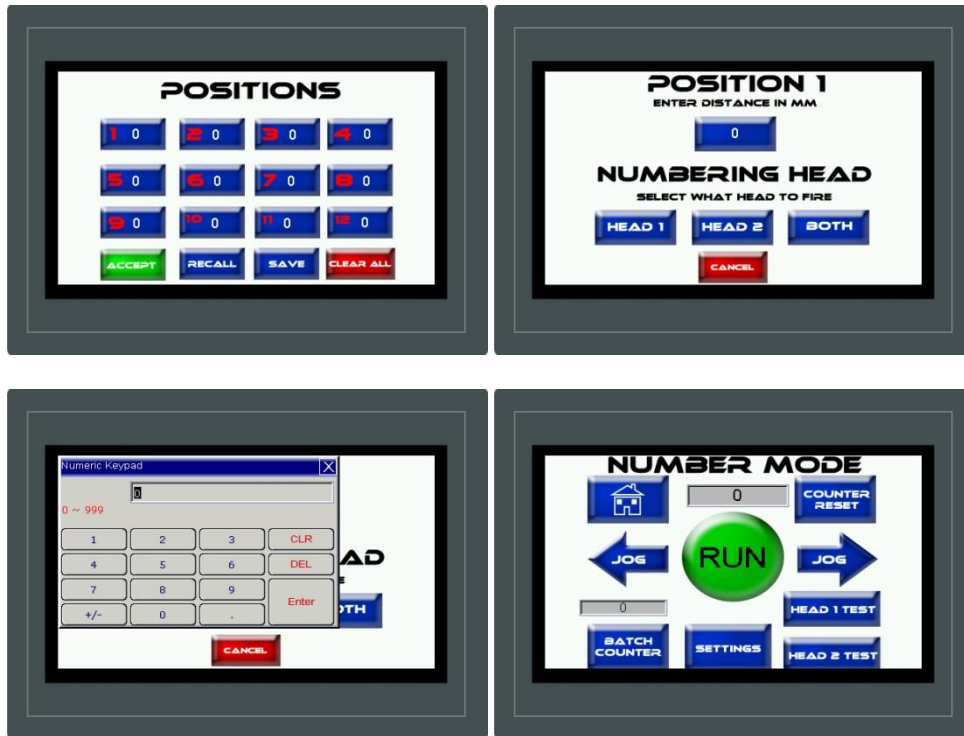

### ***SAVING NUMBERING JOBS***

Press the Number Mode Button > Enter In Distance For each Position in mm > Select Head > Save > Select Location to save in 1, 2, 3, or 4.

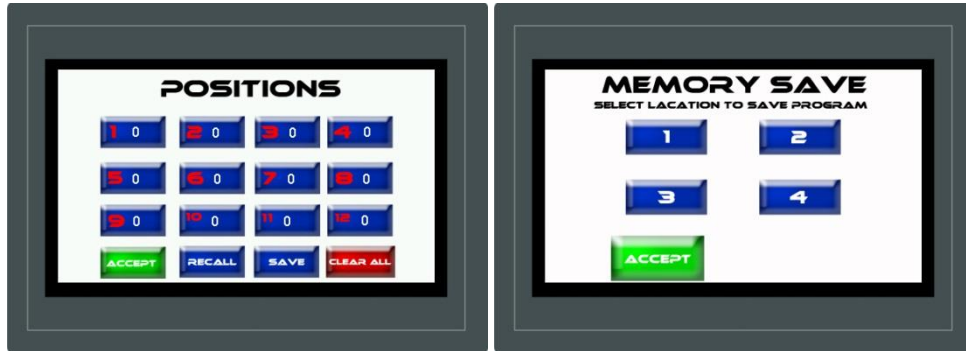

### ***RECALLING NUMBERING JOBS:***

Press the Number Mode Button > Recall > Select the Program Number > Accept > Accept > Run.

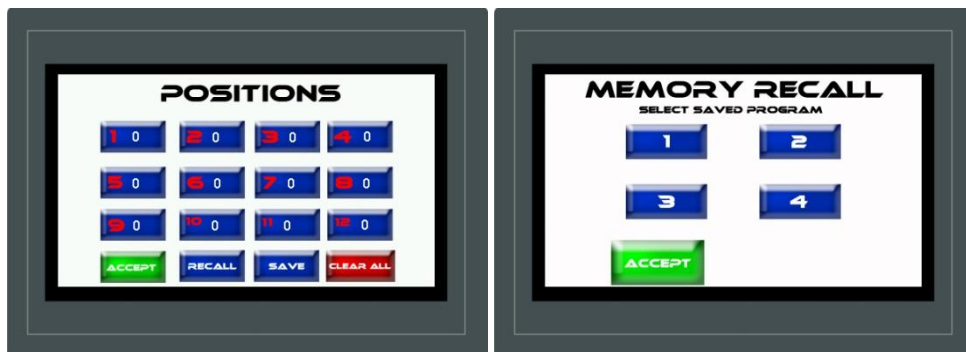



## BATCH COUNTER

Press the Batch Counter button from the run screen in any mode and it will take you to the Batch Count Screen.



Press the Enter Batch Amount Button to enter in the number you want to run per batch.



Press the Reset Batch Button to start from 0. Press the On Button. The button turns red as shown below.



As you are running and the batch number is reached the screen will display "Batch Complete".



## FEED TABLE ASSEMBLY

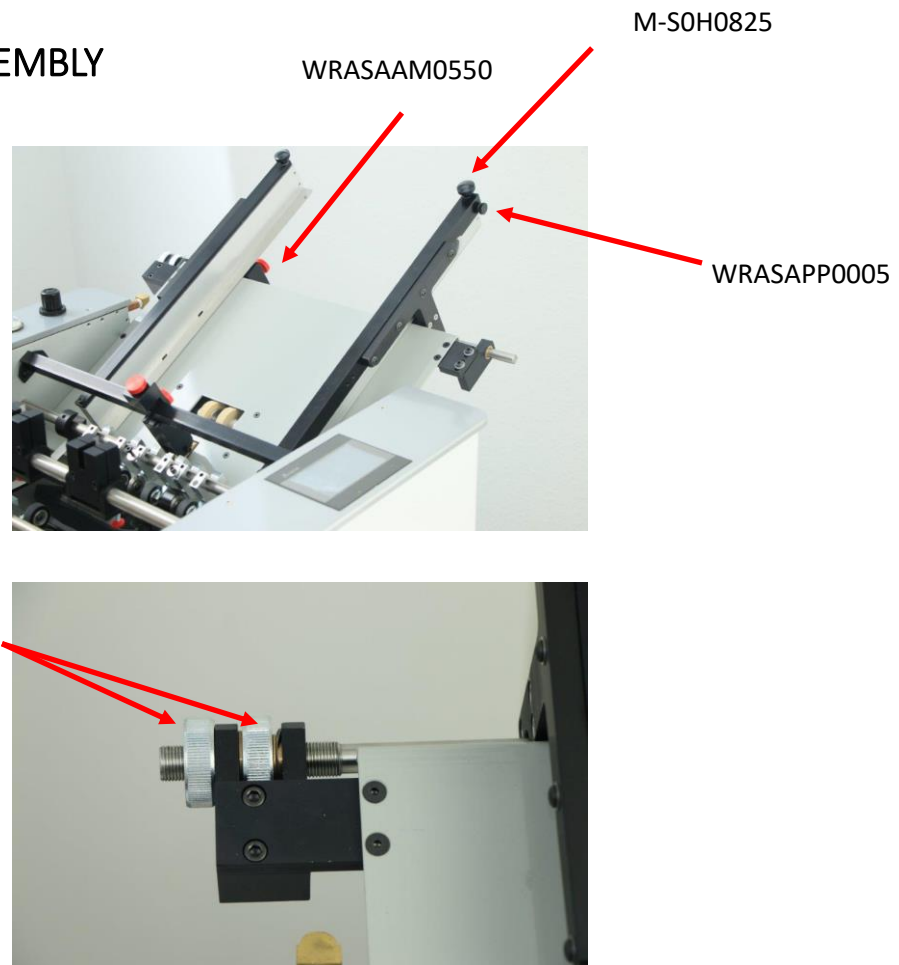

**Feed Rail Lock Knob – WRASAAM0550**

**Locks the position of the feed rail laterally.**

**Nut –Adjustment Feed – W-OF0640**

**Use this to adjust the lateral position of both rails at the same time.**

**Micro-Lateral Adjustment Lock – W-OF0640**

**locks the adj. nut.**

**Micro Skew Adj Knob – WRASAPP0005  
(knob T w/ ¼'-20 thread)**

**Adjusts the Skew of the feed rails (see adjusting the feed rails)**

**Feed Rail Lock Down – M-S0H0825  
(knob)**

**Lock for the micro Skew Adjustment**

## ADJUSTING THE FEED RAILS

Each machine is tested and will come to you with the feed rails squared by our quality assurance department. The feed rails on your Auto Pro Touch are designed to adjust easily in case of a problem with skewed feeding. By loosening the feed rail alignment lock knobs you can move each rail independently to square them to your stock. To maintain an accurate perf or score, it is important to get the rails as aligned and snug to the sheet as possible without “squeezing” the sheet, as this will create drag and cause the sheets to hang up in the rails.

To adjust this correctly, use one rail as your reference, the left (operator side). Place your stock squarely against it then bring your right rail in and tighten, looking down it from the rear. Adjust the rail with the skew adjustment knob so it is squared to the sheet. Then tighten the lock knob, and place your AUTO PRO TOUCH in perf mode. Set a sheet in the feeder, under the feed wheels, then press run.

Check perforation by folding over and aligning the perforated edge.

Perforated holes should line up within a blade’s width (.01 in). If they do not line up, adjust rails accordingly, moving your non-operator side rail first and then adjusting the operator side rail to square the sheet. This may take a few attempts, but this adjustment is important to produce quality perf and score jobs.

### EXAMPLE:

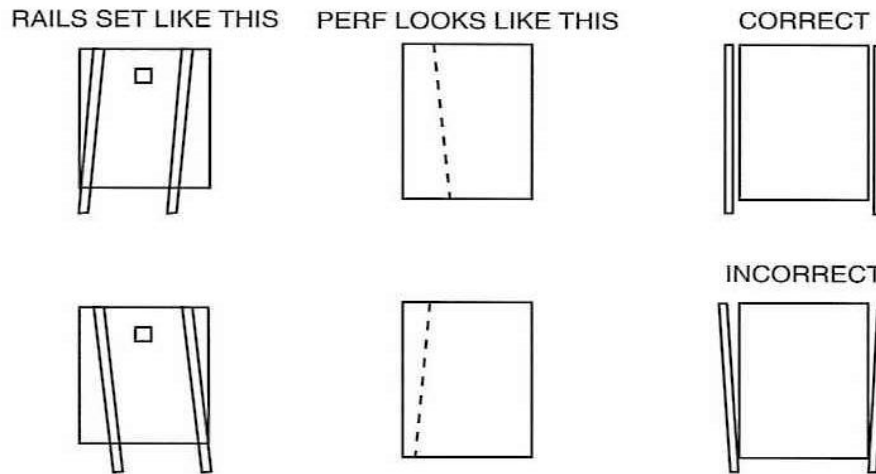

## SQUARING THE FEED RAILS

To do this, take a sheet of 8 1/2 x 11” cover stock and place it in the feed table against the operator side guide. Pressing the sheet against the rail, slide the rail over so that the front edge of the stock lines up to the front edge of the feed table. Loosen the feed rail adjustment lock knob, and use the skew adjustment knob to adjust the rail so that the sheet is aligned with the left to right with the edge. Once this is done, slide the opposite side guide into position and adjust it to the edge of the sheet. Your rails should now feed the sheet perfectly aligned, providing a straight perf or score.

## PAPER CALIPER ASSEMBLY COMPONENT IDENTIFICATION

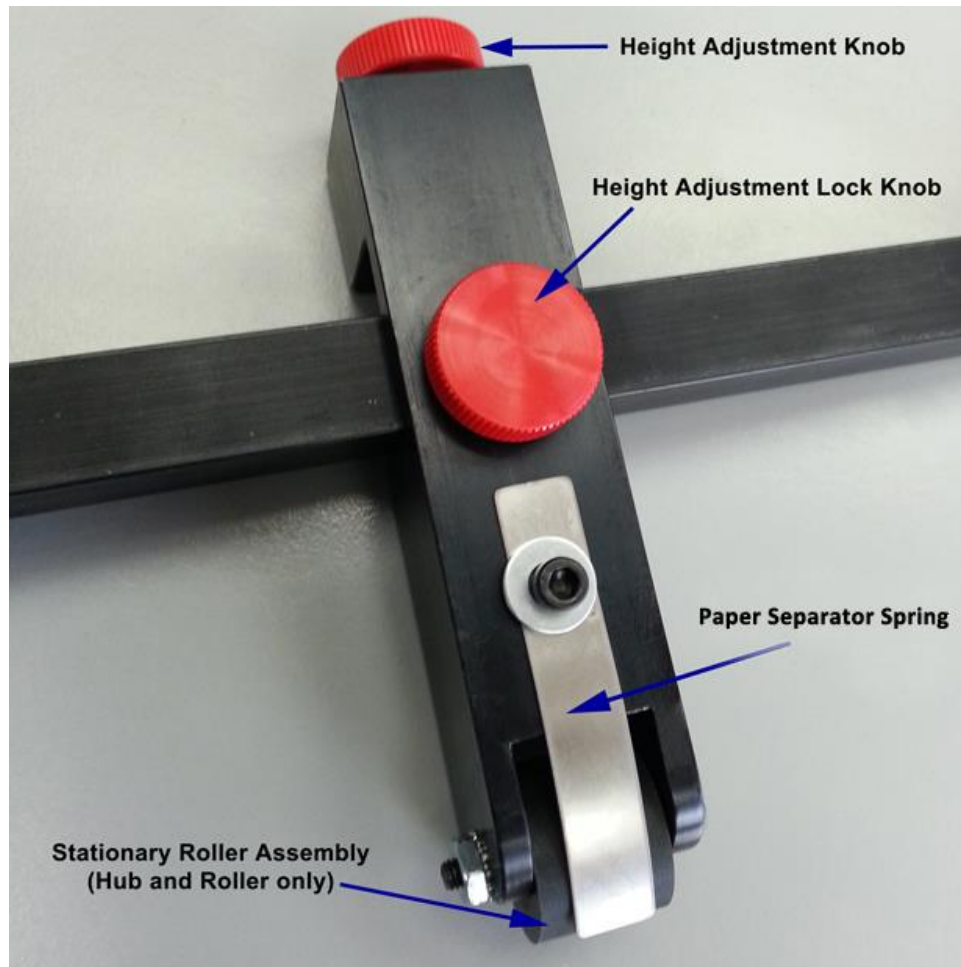

|                               |             |  |
|-------------------------------|-------------|--|
| Height Adjustment Knob -      | WRASAAM0610 | Raises and lowers stationary roller to adjust for paper thickness.   |
| Height Adjustment Lock Knob - | WRASAAM0600 | Locks the height adjustment assembly in position after correct setting is achieved.                            |
| Paper separator Spring -      | W-OFS340    | Fans stack and works with stationary roller to correctly space sheets for feeding and prevent jamming.         |
| Stationary Roller (Std.) -    | W-AF2165    | Rubber wheel which is adjusted to the paper thickness. This wheel does not turn! (This is a replaceable part.) |
| Stationary Roller (Soft) -    | W-AF2166    | Rubber wheel which is adjusted to the paper This wheel does not turn! (This is a replaceable part.)            |

## ***PAPER CALIPER ASSEMBLY HEIGHT ADJUSTMENT FOR PAPER THICKNESS***

To adjust this for your job, turn your Auto Pro Touch on and set the machine to run. Loosen the height adjustment lock. Hold a sheet under the Caliper Assembly and using the height adjustment knob lower the assembly until you feel a slight pull. The stationary wheel should be barely touching the sheet. While still holding the sheet under the stationary wheel, tighten the lock slightly making sure the adjustment does not change. Stop transport. With the transport off, push a sheet under the assembly again. Take a second sheet and try to push it under the assembly. IT SHOULD NOT GET PAST THE STATIONARY ROLLER. If it does, release the lock and turn down the assembly clockwise very slightly and try the "Second Sheet Test" again. When this is set, place 10 to 20 sheets in the feeder. Fanning them is not required. Press advance and the stack should fan itself! Advance the first sheet out to the main roller then stop. Now press run. The sheets should move through the transport with approximately a 1" gap between them. If you get a double, place the stack in the feeder again and as the Auto Pro Touch is running, loosen by turning counter clockwise, the lock and adjust slightly until the 1" gap is achieved.

## ***ADJUSTING THE PAPER SEPARATOR SPRING***

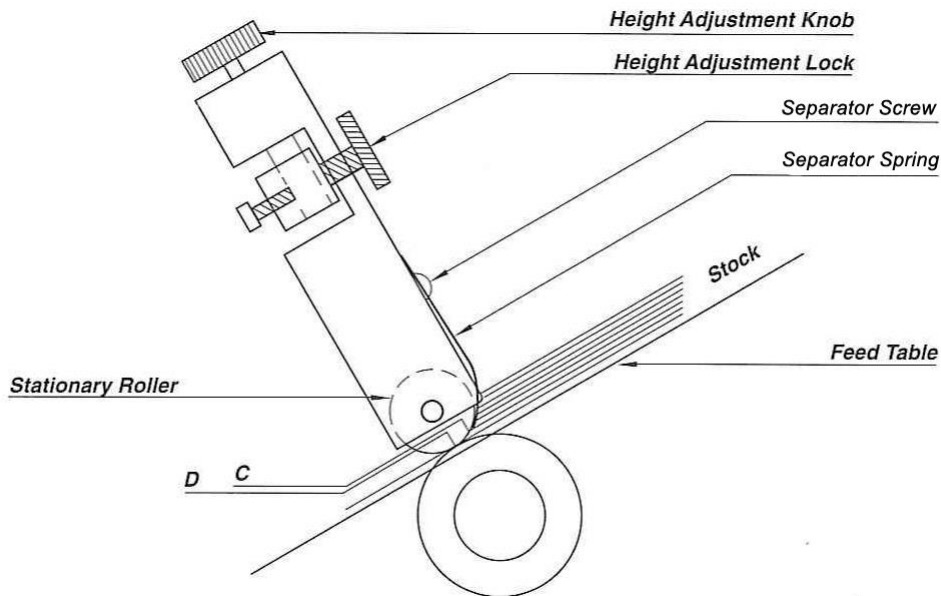

The paper separator spring is critical to the correct operation of a friction feed system. As you can see on the diagram, it is important that the spring contacts the stationary wheel and curves under it slightly. If the spring gets bent out away from the wheel, this will cause problems with doubles and sheet spacing. The height is adjustable by loosening the height adjustment lock and moving it up or down slightly. If feed problems occur, they are generally due to improper setting of the separator spring or a worn or flat spotted Stationary Roller. Note that the separator spring should contour the Stationary Roller and extend down. Point C should be slightly higher than point D. When a flat spot occurs, this places point C lower than point D which will cause doubles as the Stationary roller loses contact.

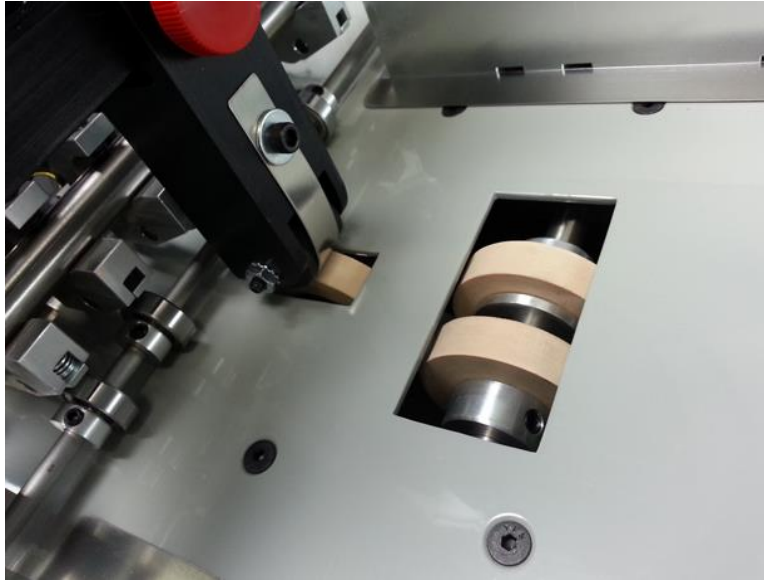

### ***CHANGING THE STATIONARY WHEEL***

The stationary wheel is a consumable part. After use it will develop flat spots and should be turned frequently so paper is always being presented to a round surface, not a flat spot. If you are having a problem with doubles on thinner stocks, try replacing this roller. This is very simply done by removing the wheel bolt and replacing the wheel. Be sure to tighten the bolt securely **as this wheel should not turn.**

GOOD

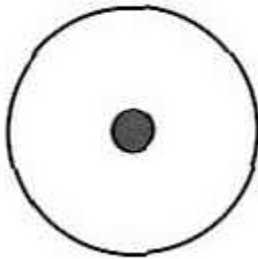

BAD

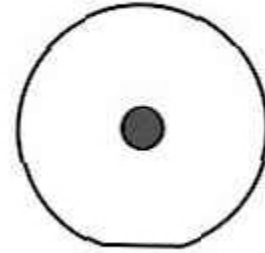

## ***LOADING THE FEEDER***

Take the paper and load the feed tray up to 1/2 of the height of the feed rails. The leading edge of the bottom sheet will slightly move forward of the one on top automatically fanning the stack.

**Note:** do not allow the machine to run with the feed wheels in contact with the stationary roller. This will cause the feed wheels and stationary roller to wear too quickly.

## ***FEEDING NOTES***

- When set properly, the friction feed is very efficient and flexible. When neglected it can become very frustrating to run even the simplest job. The adjustments previously discussed are very important as well as keeping the feed wheels CLEAN and tacky. We recommend you use water to clean the wheels.  
**DO NOT USE BLANKET WASH!**
- The Auto Pro Touch is capable of running 14 lb. single sheets, 6 part forms and 80 lb. cover. Its flexibility is directly related to the operator's experience.
- When setting up a numbering job, it is best to find the easiest way to feed the job. Then set up accordingly. For example, carbonless sets almost always feed best from the open edge. The glued edge tends to curl and cause problems with doubles as well as fold over on delivery. Also, the open edge is usually the shorter direction which consequently runs faster.
- Once your job is in progress, you can add paper to the feeder without stopping the transport. This will take a little practice as the tendency at first is to put the stack in with the weight forward, this could cause a double feed, but with practice you will figure out how to set the additional stock in with the weight to the rear. You will also notice that not all jobs are able to feed with the same pile height. An 8 1/2" x 14" two part carbonless form requires less weight on the stack to feed through properly, where as an 8 1/2" x 11" four part can stack twice as high.
- There are two types of stationary wheels available. The standard wheel which works best on carbonless sets and many other stocks. The softer wheel works better on thin stocks, 14 to 20 pound bond, stock certificates, etc... But will try to separate sets.

All carbonless sets are fed into the Auto Pro Touch with as little pressure from the height assembly as possible.

## REPLACING FEED WHEELS

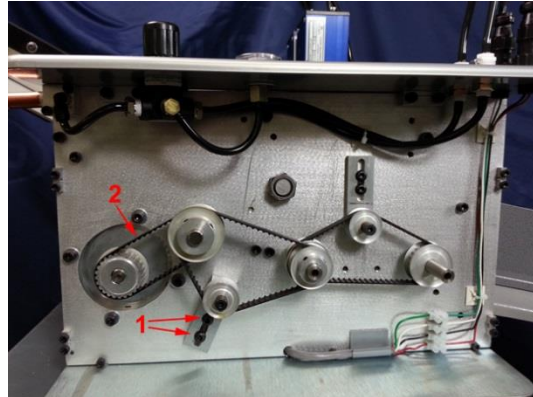
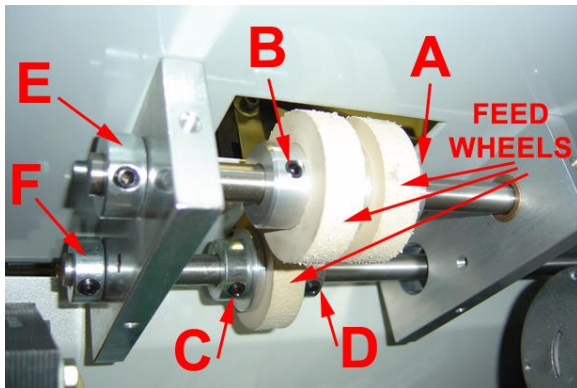

1. First remove the two rear feed wheels. **(NOTE: DO NOT LOOSEN ANY PULLEYS FROM SHAFTS.)** To do this, remove shaft collars (E&F).
2. Loosen set screws (A&B), then slide shaft out remove feed wheel hubs and replace rubbers rollers.
3. Loosen shaft collars (C&D).
4. Remove the non operator side cover.
5. Loosen the two belt tension brackets (1), and remove belts. **(NOTE: DO NOT LOOSEN ANY PULLEYS FROM SHAFTS.)**
6. Remove motor drive belt (2) do this by rotating pulley and pulling on drive belt at same time, thus allowing the belt to walk off the pulley.
7. The front feed roller shaft can now be removed allowing feed roller hub to be removed. **(NOTE: This hub has a directional bearing in it and will spin freely only in one direction. Be sure to install this hub in the same direction that it is removed or the feed table will not feed the sheets through the transport.)**
8. Reassemble in the same order for that it was removed.

## CHECKING THE SENSOR

1. Turn machine power on and allow screen to turn on
2. There should be 2 lights on the sensor a green indicating power is getting to the sensor and orange that is the reflecting signal. These are located on the bottom of the sensor and may be difficult to see. By removing the operator side cover you can check the **lights on the PLC**. The red light for X4 should be illuminated when there is a piece of paper blocking the sensor. If not the sensor needs to be replaced.
3. If all above steps work correctly sensor is working properly, if not, contact the Count Machinery Company service department.



# NUMBERING HEAD

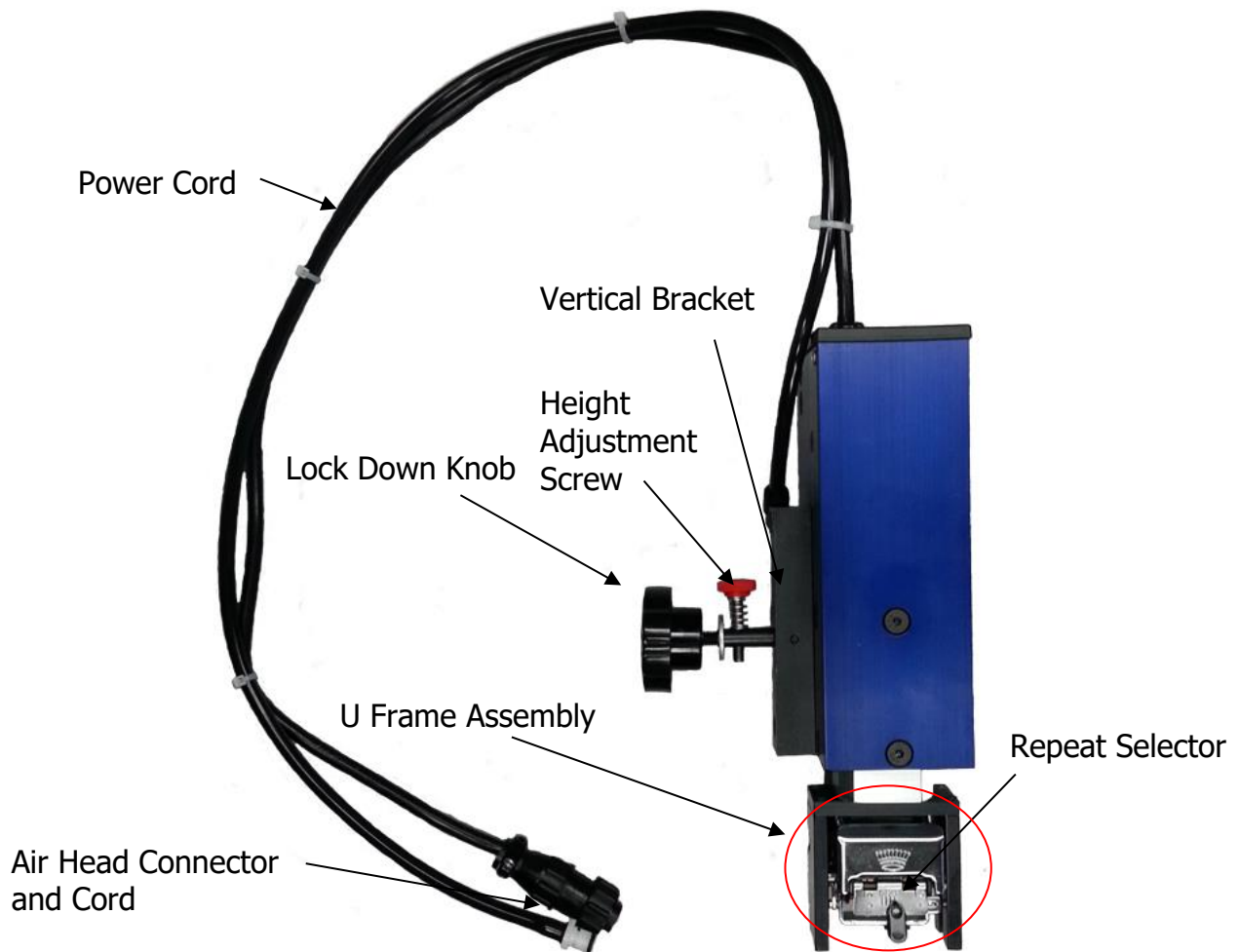

**Numbering Head**

The Numbering Heads can be operated simultaneously and the wheelset can be rotated by hand in any direction.

**Vertical Head Bracket**

Mounts to the side of the Numbering Head and positions the head into the head of the Mounting Bracket.

**Pressure / Height Adjustment Screw**

This screws into the Vertical Head Bracket Stem to adjust the pressure of the strike of the head.

**Pressure / Height Adjust. Screw Spring**

This spring is necessary to retain the setting of the screw.

**Head Lock-Down Knob**

Tightens the Head Assembly to the Mounting Bracket.

**Lock-Down Knob Washer**

Installs with the Lock-Down Knob. Knurled side toward numbering head.

**Wheel Assembly**

**Ink Swing Arm**

**Repeat Selector C Clip**

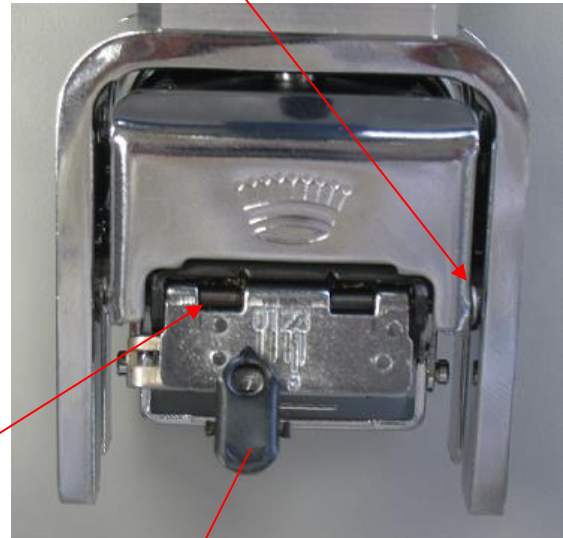

**Repeat Selector Shaft**

**Repeat Selector**

***NUMBERING HEAD PART NUMBERS:***

**Numbering Head** - W-ASFCM0100 Complete 7 digit reverse pneumatic numbering head.

**Vertical Head Bracket** - W-OF2696

**Vertical Head Bracket Assy.** - W-ASAHD0014 Complete assembly includes: W-OF2696, M-OH0475, M-S0H0835, M-S0H0575, WRASAAM0620, & 2x M-S003045 screws

**Pressure / Height Adjustment Screw** - WRASAAM0620

**Pressure / Height Adjust. Screw Spring** - M-S0H0575

**Head Lock-Down Knob** - M-S0H0835

**Lock-Down Knob Washer** - M-OH0475

**Power Cord** - M-S0E0974

**Repeat Selector** - WRASAAM0870

**Wheel Assembly** - M-S0H1135

**Swing Arm** – Comes with Wheel Assembly

## *DEPRESSING A WHEEL*

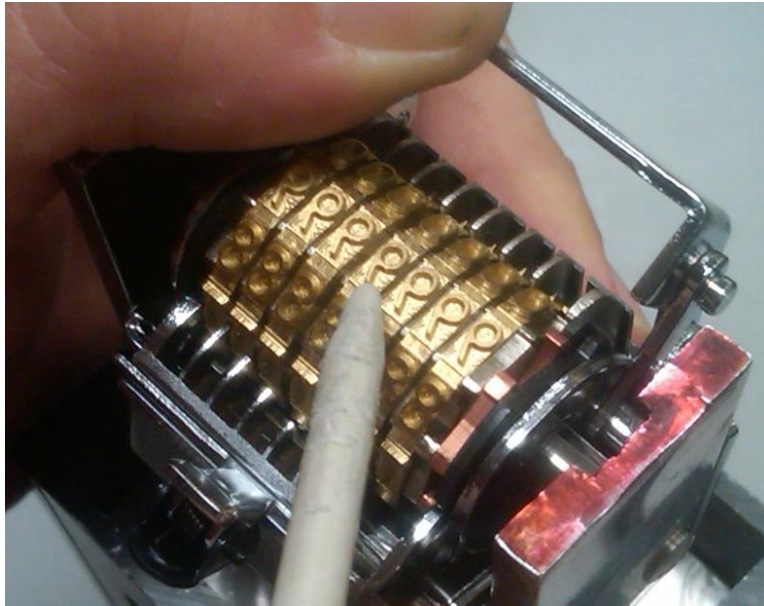

The standard Pneumatic Numbering Head can recess the first four (4) wheels so there is no image when striking. For example, to print the number 4750 instead of 0004750, you will need to depress the first three wheels. To do so, remove the Numbering Head from the Head Bracket and hold it upside down resting it on a flat surface. By doing this the flat surface will press the Test Print button located on the top of the numbering head case. This will keep the head in the “Open or Down” position for as long as the button is depressed. This will swing the Ink Cartridge away from the wheels or you can remove it altogether. Using the provided set-up tool rotate the 1st wheel until the 9 is in the up position. Then press forward slightly and down, you will feel the wheel depress below the level of the others. Do the same to the 2nd and 3rd wheel. Now you can print a 4-digit number. To return to position, simply rotate the wheel and it will pop up. This feature is also available on the custom Numbering Wheel with letters. Rotate the wheel until the blank position is up then press forward and down.

## *CHANGING PRINT ORIENTATION OF THE HEAD*

Changing the print orientation of the number is done very simply by firmly twisting the U-Frame and rotating the numbering wheels in either direction. This U-frame is held in place by an O-ring that when set will firmly hold the numbering head in the set position. The ideal way to change direction of the numbers is to twist the U-frame slightly past where you want the number to settle and then back a little to your ideal position. This will allow for the rubber O-ring tension to be released as after turning the U-frame the O-ring will settle back a little from where you set it.

## *ADJUSTING THE VERTICAL BRACKET*

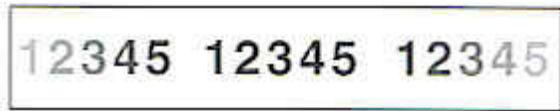
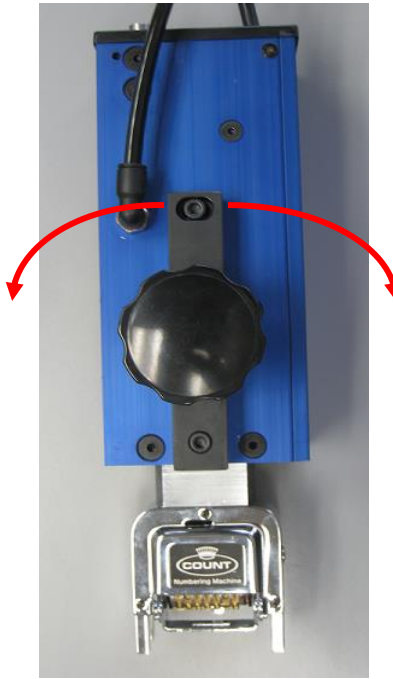

The machine comes with the numbering head leveled correctly from the factory. The top of the vertical bracket is slotted to allow for movement. The effect of this movement depends on the orientation of the head. To make an adjustment to the vertical bracket, simply loosen the top screw and slide toward the direction desired, then retighten the screw. It is not necessary to loosen the bottom screw. This will allow you to compensate for a number that is heavier on one side and lighter on the other.

## *ADJUSTING FOR A LEVEL IMPRESSION*

To begin the leveling process, move your numbering head to the desired lateral position on the bar. To do this you must first loosen the two cap screws on the mounting bracket. Then loosen the head lock down knob on the head to allow head to slide into the mounting bracket. When these are both released, the head and bracket will slide along the bar. By using your horizontal adjust screw (Red knob on the bottom side of the mounting bracket) you can adjust the angle of the number. Clockwise rotation will tilt the numbering head higher on the feed side. Turning Counterclockwise will tilt the numbering head higher on the exit side of the machine.

Your vertical adjust pressure / adjust screw (Red Knob on the head) will adjust the height of the numbering head from the strike plate. Use this knob for fine adjustments to pressure as well as

levelness prior to tightening lock down knob and mount bracket cap screws. You are now ready to number.

### ***TIPS FOR LEVELING HEAD***

Leveling the numbering head is the most critical part of the set up process. If the head is not level you will get a blurred or “Ghosted” Impression. This can also occur when the head is set to hit too lightly or too heavy. Never set pressure to favor the drop wheels. This will depreciate the life of the numbering wheels.

The easiest way to check your impression is to use a 3 part carbonless set. Program the Auto Pro Plus to stamp in one location anywhere on the sheet. Run your test sheet through the machine and check impression for pressure as well as levelness. By level it refers to a level impression. Where the impression of the 1st digit is the same pressure and impression as the 5th and 6th digit and the top of the digits is the same as the bottom you are level. We do not mean “plumb level,” as using a small level will not help.

### ***SETTING THE REPEAT SELECTOR***

This allows you to select the number of times that the head will strike without advancing to the next number.

EXAMPLE: If you need to number a job which requires the same number in two (2) positions, slide the selector to “2.” The head will now strike the same number twice.

**NOTE: After selecting a repeat sequence, replace head and run a test sheet through the Auto Pro Touch.**

You should get this:

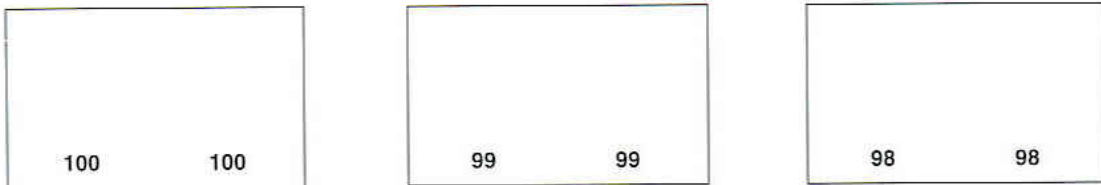

If you get this:

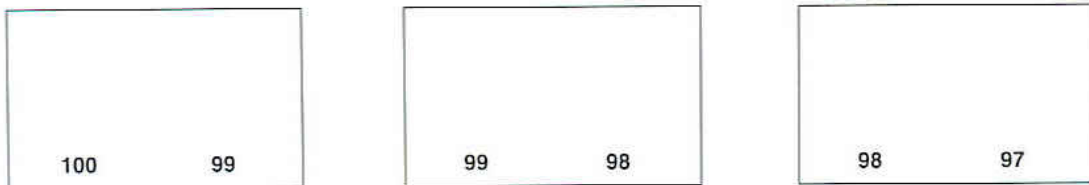

The number changes at the wrong strike, the wheel cam is not in sync with the paper. To remedy this, you must get the head to fire 1 time. This can be done by pressing the test fire

button on the top of the numbering head one (1) time. The cam is now in the correct changing sequence.

## *INK CARTRIDGE*

The ink cartridge slides under the swing arm and locks into place. When installing a new ink cartridge, first remove the foam pad using an X-acto knife and place a small cut into the reservoir. This will supply ink to the foam through the action of the swing arm. Start with a small hole as it is easier to make the hole larger, but if you start with the hole too large you cannot control the flow of the ink.

**NOTE: The flow of ink can be sensitive to temperature. On a cold day the ink will be thicker and not flow easily, whereas on a hot day the ink will be thin and flows faster. Also, be sure to shake cartridge well.**

We also suggest that when opening a new cartridge to use the piece of tape which holds the cover on to wrap around the cartridge about 1/4 of an inch. This will help reduce excess ink on the numbering head especially when only using 3 or 4 digits where the foam would have a tendency to lift on the opposite side.

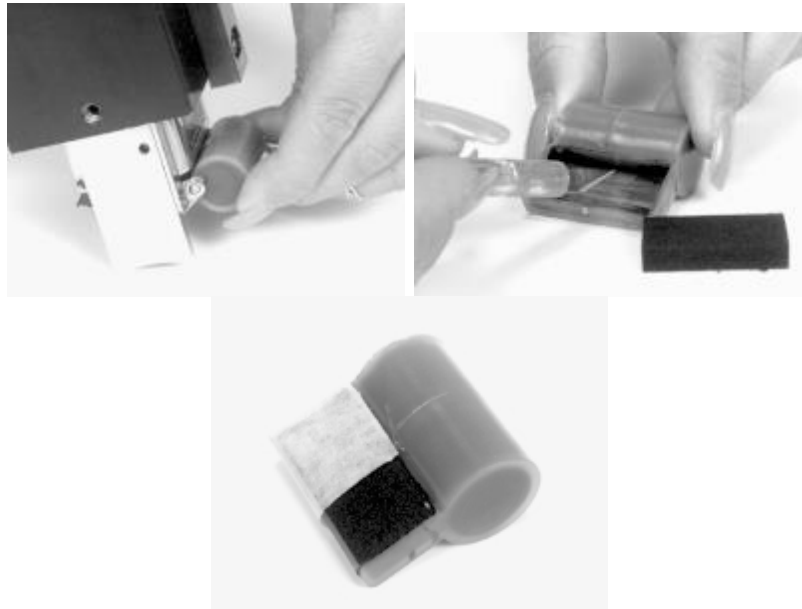

## *AIR COMPRESSOR*

Never connect to an air source that can exceed 200 PSI. Over pressurizing the tool may cause bursting, abnormal operation, breakage of the regulator or serious injury to persons. Use only clean, dry, regulated compressed air at the rated pressure below. Always verify prior to using the tool that the air source has been adjusted below the maximum. Maximum Air Pressure 120 PSI, Air Consumption 0.5 CFM @ 90 PSI.



## PERF SHAFT & STRIKE PLATE

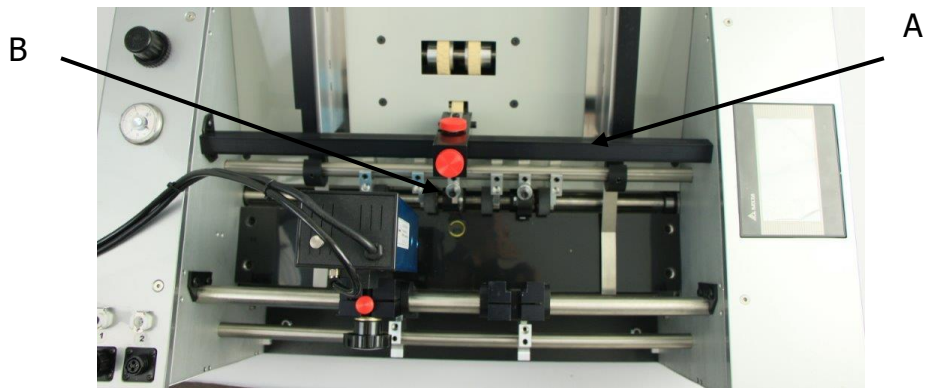

**A** – Support Bar – W-OF0232

This is the shaft that the roller wheels and perf score are mounted on.

**B** – Lower Sensor Eye Assy. – M-S0E1317

Located in the platen strike plate.

## REMOVING THE PERF SHAFT

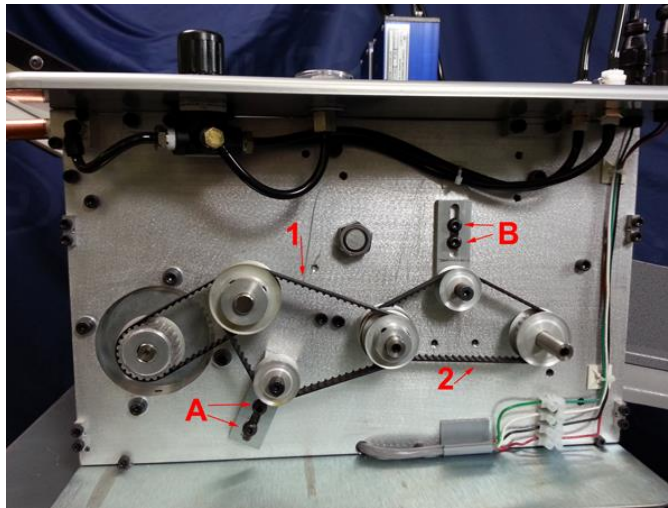

Remove the non operator side cover. Locate and loosen the 2 set screws holding the shaft near the operator side frame. Loosen both belt tensioner idler pulley's screws A and B. You do not need to remove these as loosening them will allow enough movement to free the belts of the perf shaft. Remove Belts 1 then 2 and slide the perf shaft out of the machine. Slide the perf shaft out the pulley side. It is only necessary to slide the shaft out about 6 to 8 inches. With the shaft slid to the side, you can access the lower hubs and reconfigure them as needed to complete any job. After you have configured the lower shaft, replace the shaft into its bearing and secure the set screws. The shaft should not be able to move side to side. With both drive belts in position, re-tension the belt idlers and tighten while applying constant firm pressure on the belts by pushing down on the tops of the brackets. Replace cover. Align upper assemblies accordingly.



## PERFORATING AND SCORING ASSEMBLIES

Remove the (1) button head cap screw. **BE SURE TO TIGHTEN THE SET SCREW SECURELY TO THE BAR.** Once you have the upper and lower perf assemblies in place, you can tighten the set screw. In order to set the perf, align the upper and lower perf assemblies in the location you want them to be on the sheet. It is important that the perf blade be aligned directly in the center of the lower assembly. You will see a line where the perf blade has been run for quality testing in the center of the stainless steel lower assembly. Line up the perf blade as close to that line as possible. The lower assembly has a rubber core to allow some give which extends the life of the actual perf blade. If the perf blade is toward the edge of the stainless steel lower assembly the rubber core will angle and the perf will not be as accurate. The perf depth is adjustable by the screw on the top of the upper assembly. The tighter you turn the screw the more pressure and thus the deeper the perforation. As the Auto Pro Touch can perforate through a wide variety of stocks this is a very important adjustment. For a good standard starting point use your T-handle wrench to tighten the spring loaded screw on the upper assembly until you feel the perf blade touch the lower assembly. From this point turn the T-handle screw  $\frac{1}{4}$  turn tighter. This will put pressure on the blade and should make a buzzing sound when the machine is in run mode. For lighter stock you may have to loosen the adjustment screw a little and with heavier stock you may need to tighten the screw a little. Our perforating system is very flexible and allows for easy, on the fly adjustment. Note: If you do not have enough pressure on the perf blade the perf will not be consistent and you will see the perf alternate between lighter and deeper down the length of the sheet. Generally this is corrected by lowering the perf a little bit more. If you need to tighten the perf to the point where it's almost slitting the paper in order to perf your perf blade is probably worn down or you may need a deep cut perf blade if you're running a heavier stock. Note: When trying to line your perforation up on a precise location on your sheet, you can utilize the micro-lateral adjustment wheel to move the rails together and the sheet to the right or left in very small increments.



**Optional Score Assembly: WRASAPP0129**



**Perf Assembly Complete: WRASAPP0139**

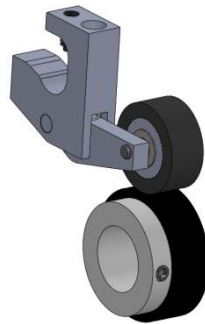

**Spring Loaded Roller  
Assembly Complete: WRASAAM0933**

## GRIPPER WHEEL PERF-SCORE MOUNTING

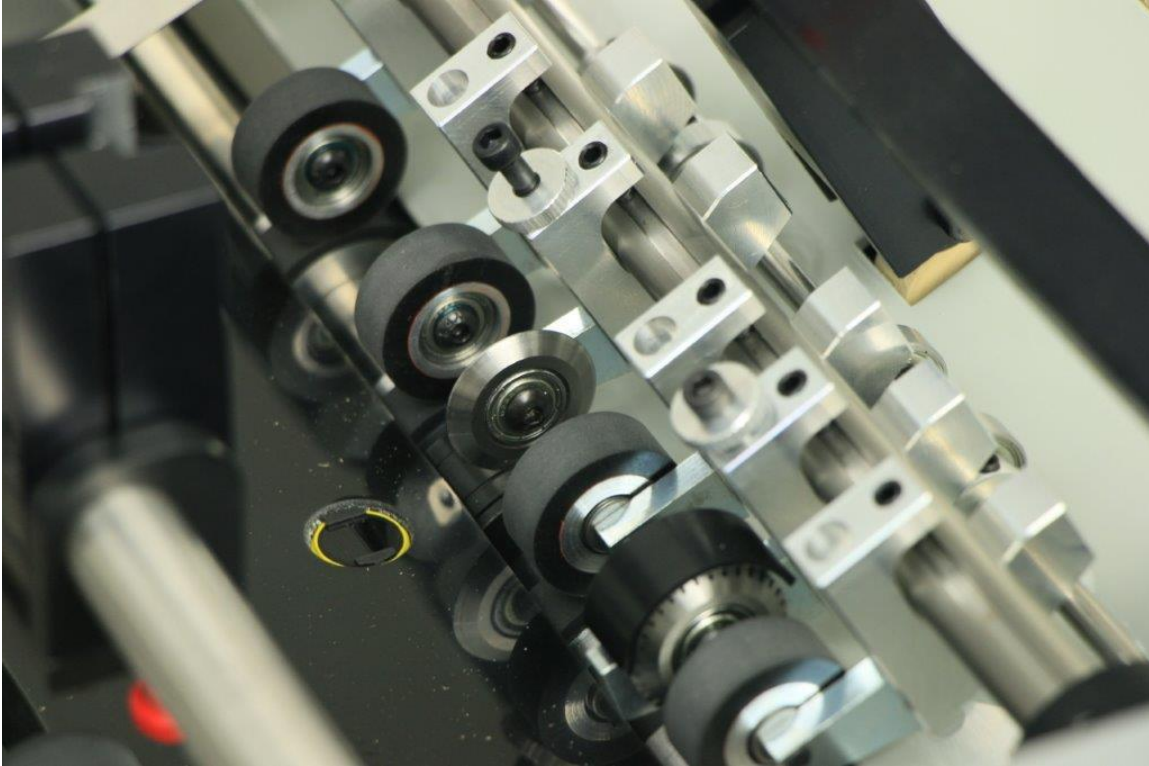

The rollers will come from the factory set up to run an 8.5in sheet of paper. When changing paper size all the rollers should be placed in the paper path and evenly spaced. The rollers should never be placed within 1in of the edge of the sheet of paper. The more rollers used the more control you have on the sheet. **This** is very important for the registration of the machine and will directly reflect in the repeatability of the number placement.

Position your score blade as desired. Scores should be made so that the blade runs on the side of the sheet that will be on the outside of the finished fold. Scores may be made on the AUTO PRO TOUCH in three different ways using the different grooves on the lower score assembly.

# TROUBLE SHOOTING

- **POWER DOES NOT TURN ON**
  1. Check breaker on back panel.
  2. Check outlet for power.
- **FEED TABLE NOT FEEDING CORRECTLY**
  1. Check Height Caliper Adjustment.
  2. Rotate Stationary Roller.
  3. Check Separator Spring.
  4. Remove some stock from pile to lessen weight.
  5. Check Rails for pinching.
- **SHEETS NOT FEEDING STRAIGHT**
  1. Unequal feed wheel pressure.
  2. Align feed rails “check for squareness”. This can be checked by the lead edge of the paper feeding into the machine should line up with the front edge of the feed plate.
  3. Not enough pressure on forwarding rollers.
  4. Clean ALL rubber rollers.
- **PERF IS NOT STRAIGHT**
  1. Check for equal pressure on all grip wheels and that none are hanging up.
  2. Recheck all steps under (SHEET NOT FEEDING STRAIGHT)
- **PERFORATION IS NOT CLEAN OR CUTS SHEETS**
  1. Not enough pressure on perf wheel.
  2. Perf blade is worn.
- **NUMBERS NOT REGISTERING ON SHEET:**
  1. Clean all rubber rollers.
  2. Check pressure on grip wheels. If these are not down firmly your registration will be off.
  3. Be sure paper guide bearings are not set in line with feed rails.
  4. Check all pulleys to make sure are securely tightened to shafts.
  5. Check to see that machine transport turns freely.
- **NUMBER APPEARS BLURRY:**
  1. Head is not level. See “leveling a head” page 21,22.
  2. Not enough pressure, adjust with height adjustment screw.
  3. Too much pressure, solenoid cannot make full stroke.
  4. Head not tightened properly to head bracket.
  5. Ink cartridge is empty or flow of ink is not consistent (**TRY ROTATING THE INK PAD**)
- **HEAD FIRES BUT NUMBER DOES NOT ADVANCE:**
  1. Head set too low cannot make full stroke
  2. Possible damage or broken action indicator.
  3. May need to send to the Count service department for repair.
- **NUMBERS TURN OUT OF SEQUENCE:**
  1. Head is dirty. Clean with Simple Green then oil with 3-in-ONE oil.
  2. Head is worn or damaged, contact COUNT service department.

Page left blank intentionally



**By Martin Yale Industries**

251 Wedcor Avenue, Wabash, Indiana 46992  
count-usa.com | 800-225-5644 | info@martinyale.com

M-S027954

Rev 1. 03-21