

UCHIDA

AeroCut Velocity

OPERATION MANUAL

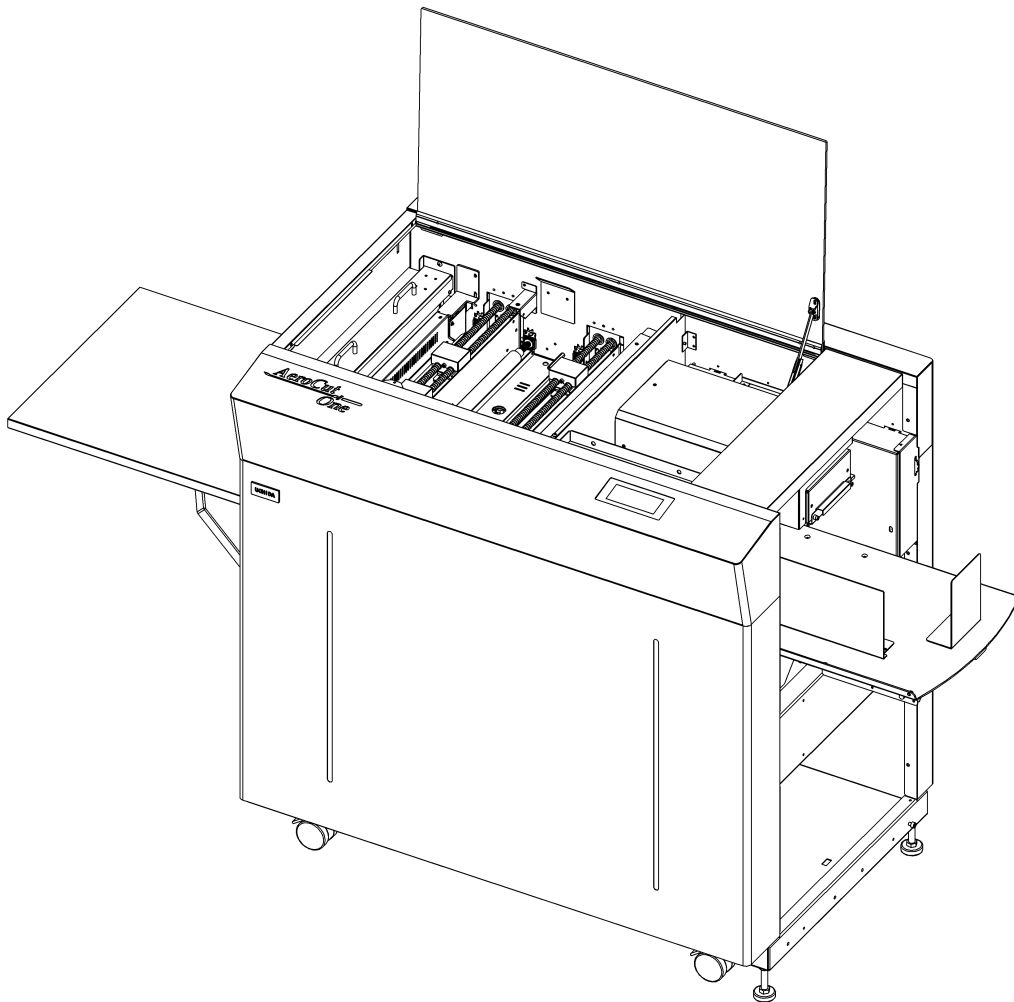



UCHIDA YOKO CO., LTD., TOKYO, JAPAN

xx-xxx V1.00

- Use machine only after reading the "Safety Instructions" given below carefully.
- These safety instructions are given to ensure that the machine will be used safely and properly and to prevent operators from sustaining harm and injuries.

Explanation of markings

Marking	Meaning of marking
 Warning	This symbol stands for immediate danger threatening the life and health of persons. Disregarding these instructions may cause severe damage to health and even serious injuries.
 Caution	This symbol stands for an endangering situation that may occur. Disregarding these instructions may lead to slight injuries or damage to property.

Definition of Symbols and Notes

In this manual the following names and signs stand for possible dangers.



Caution

This symbol stands for an endangering situation that may occur. Disregarding these instructions may lead to slight injuries or damages to property.



Note

This symbol stands for notes, operational hints, and other useful information. They are convenient for exploiting the machine's functional abilities.

SAFETY INSTRUCTIONS

Explanations of the illustrations used in the Safety Instructions are given as follows:

 Warning
<ol style="list-style-type: none"> 1. Don't open the cover of the equipment. There is a danger of receiving an injury or electric shock. 2. Don't touch any rotating part. There is a danger of receiving an injury. 3. Don't put hands inside work area. May result in severe injury.



Caution

1. Don't put a hand into the cover or a clearance between parts. There is a danger of receiving an injury.
2. Don't bring a hand, face, hair, sleeves of clothes and the like close to the rotating parts of the machine. There is a danger of receiving an injury.
3. Don't touch the blade point of the cutter. There is a danger of receiving an injury.
4. Turn off the power supply beforehand when setting the feed table. There is a danger of receiving an injury.
5. Turn off the power supply beforehand when removing paper scraps. There is a danger of receiving an injury.
6. Do not exceed the MAX level when stacking the paper. Exceeding it may cause a mechanical failure.
7. Turn off the power supply beforehand when starting maintenance or inspection. There is a danger of receiving an injury.
8. When you install a machine, please install to a place with no dust, and the place which is not influenced with a liquid. It becomes the cause of failure if the installation method is mistaken.
9. When you put a machine into operation, please change into the state where all covers were closed. If it works where a cover is opened, there is fear of an injury.

Before use

Read this "Operation Manual" carefully before use. In particular, be sure to read "Safety Instructions" (page 2 to page 3) to ensure that the machine will be used properly.

Keep the manual at an appointed place with care so that it may be accessible whenever necessary.

The specifications of this product are subject to change for improvement. Therefore, don't mistake the "Operation Manual" of one product of the same model for that of another because descriptions in the "Operation Manual" of products of the same model may differ.

Contents

1	Introduction.....	6
1.1	Names of parts	6
1.2	Accessories	8
1.3	Touch panel	8
1.4	Paper weight / quality	9
2	Operating instructions	10
2.1	Lock a caster brake	10
2.2	Turning the power on.....	10
2.3	Initial position.....	11
2.4	Input	11
2.5	Set.....	12
2.6	Paper setting	12
2.7	Stacker and Waste box settings	13
2.8	Start.....	15
2.9	Stop	15
2.10	Waste disposal.....	17
2.11	Power off	17
3	Cut pattern input.....	18
3.1	Outline	18
3.2	PRESET	18
3.3	MANUSET	20
3.4	FLEX MODE.....	23
3.5	SAVE / READ	25
4	How to use options.....	27
4.1	How to attach the Y-perforator	27
4.2	How to adjust the Y-perforation location	28
4.3	How to adjust the depth of Y-perforation.....	29
5	Adjustment	30
5.1	Adjustments on the paper feed section	30
5.2	Speed change	32
5.3	Skew adjustment	33
5.4	Creaser adjustment	33
5.5	Fine adjustments on processing positions.....	34
5.5.1	In cases cutting positions don't match to image positions	34
5.5.2	If the cut measurement does not match the input value	35
6	Manual control.....	37
6.1	Manual control screen	37





6.2	Paper jam	37
7	Error messages	38
8	Troubleshooting	43
9	Product specifications	45

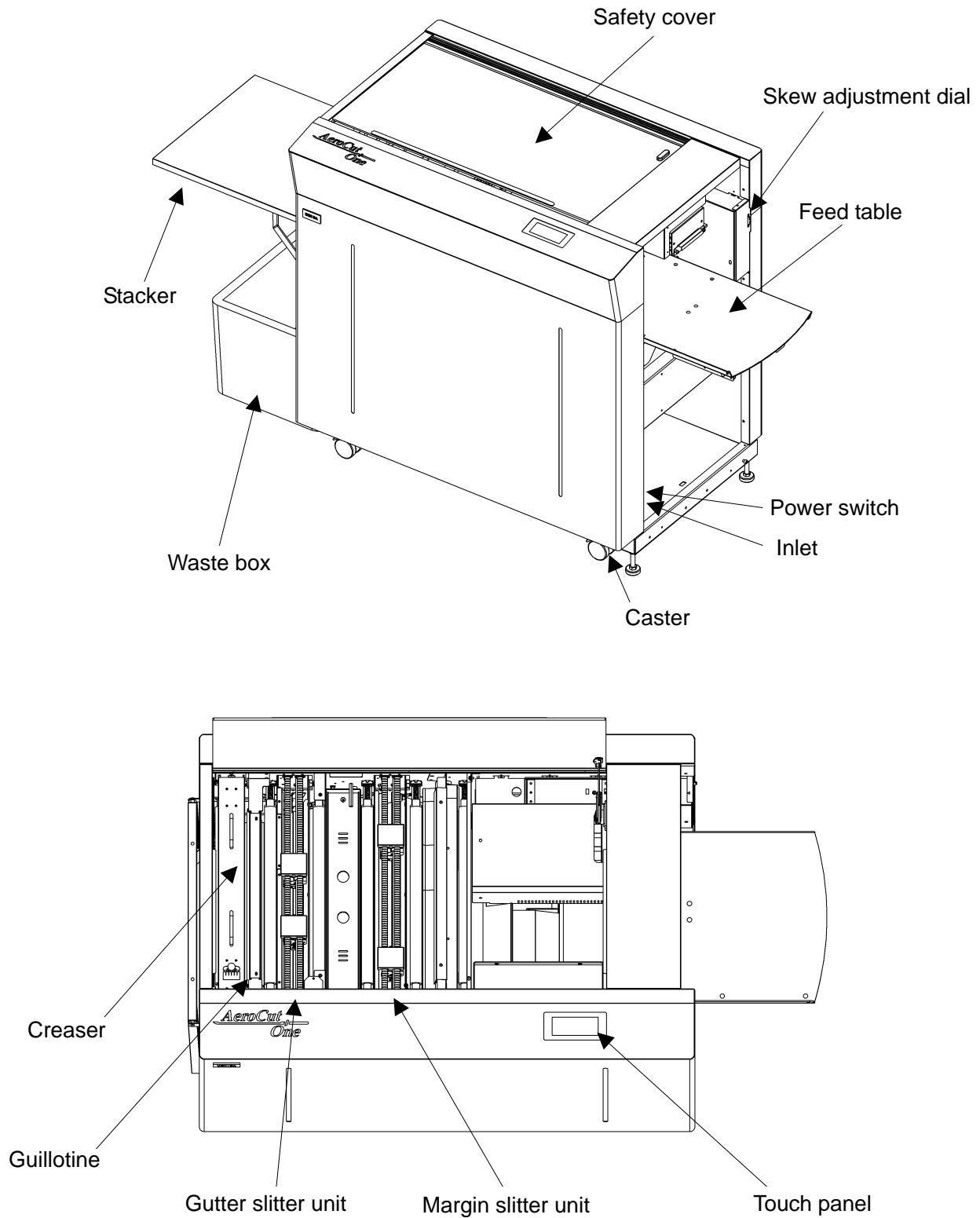

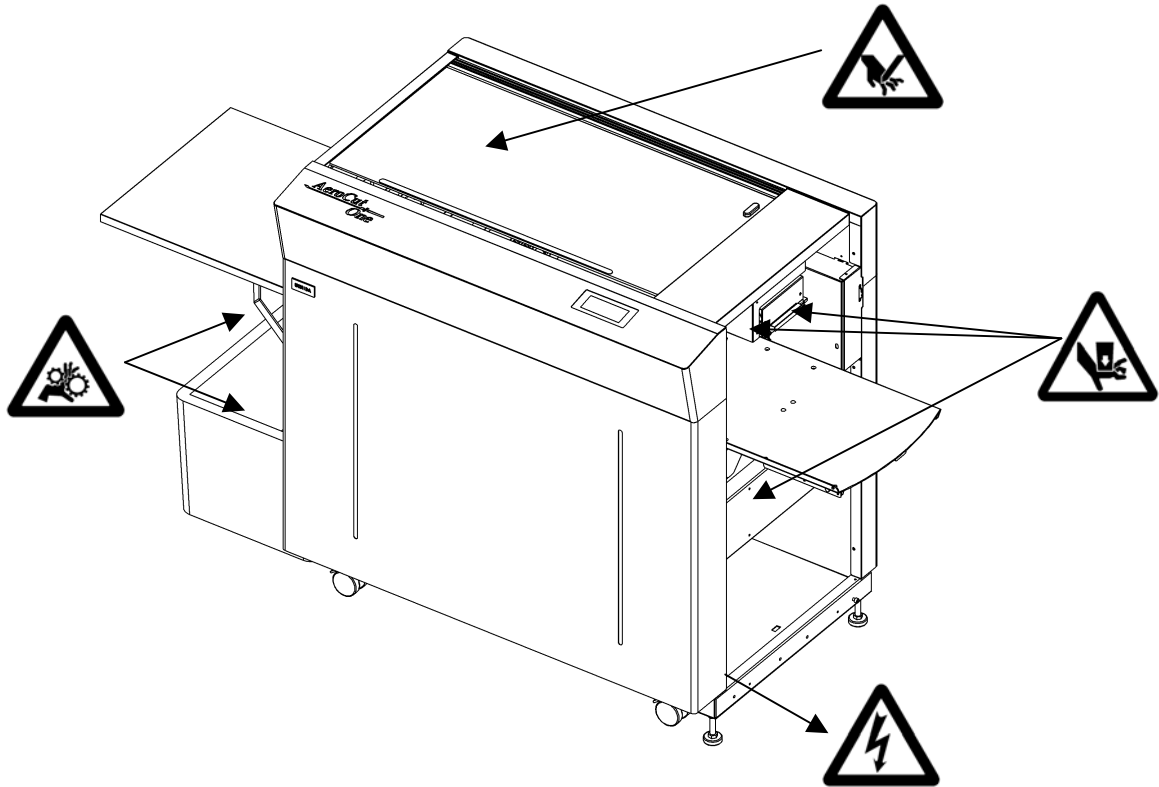
1 Introduction

1.1 Names of parts





 Warning	
	Don't put hands inside work area. May result in severe injury.
	Don't touch any rotating part. There is a danger of receiving an injury.
	Don't open the cover of the equipment. There is a danger of receiving an injury or electric shock.

 Caution	
	Don't touch the blade point of the cutter. There is a danger of receiving an injury.

1.2 Accessories

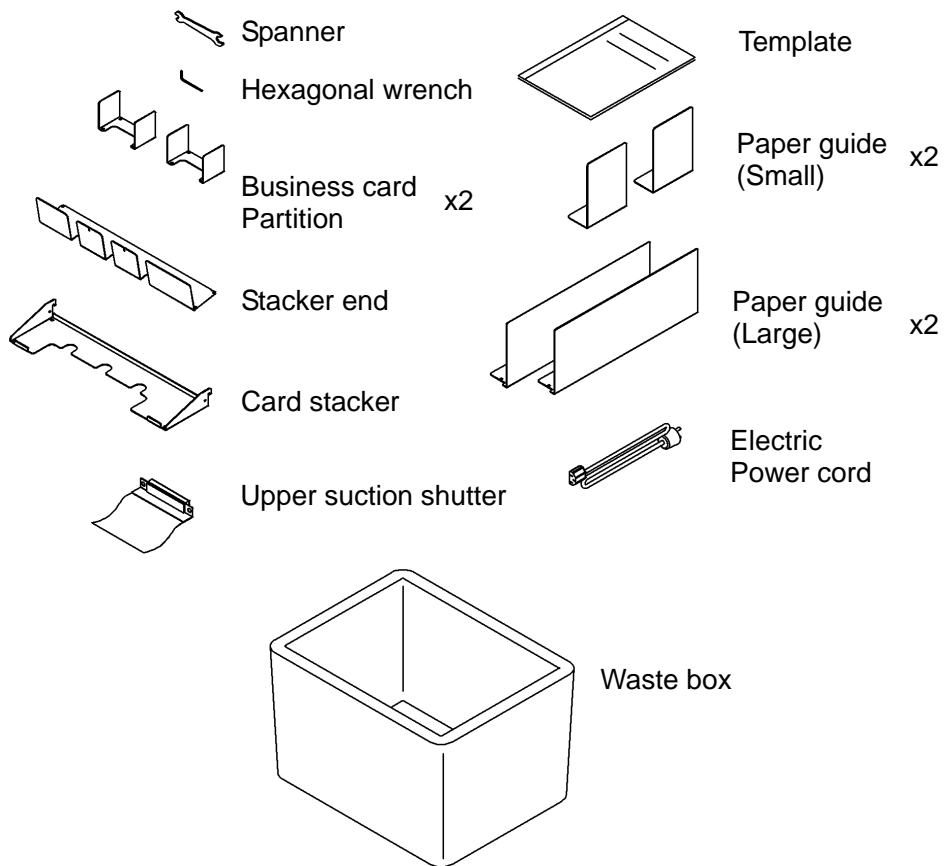

1.3 Touch panel

Home screen

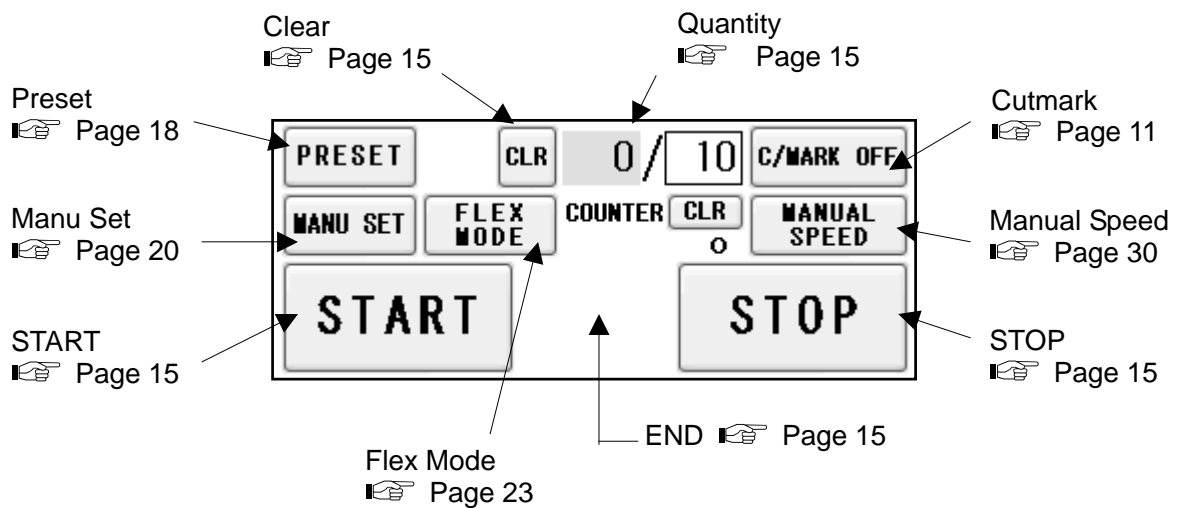

Manu Set screen

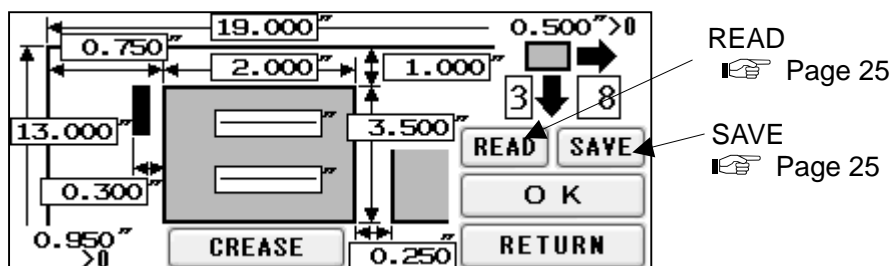

Flex Mode screen

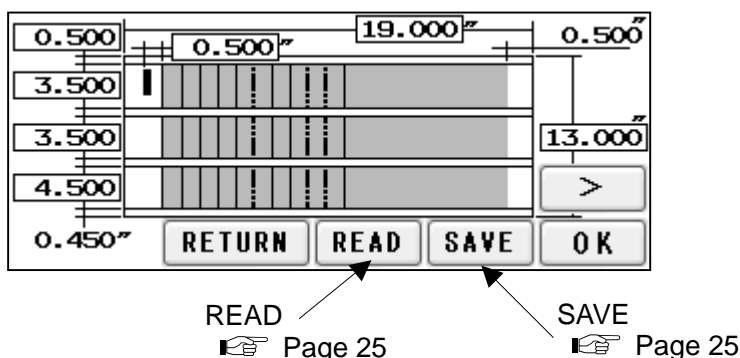

Manual speed screen

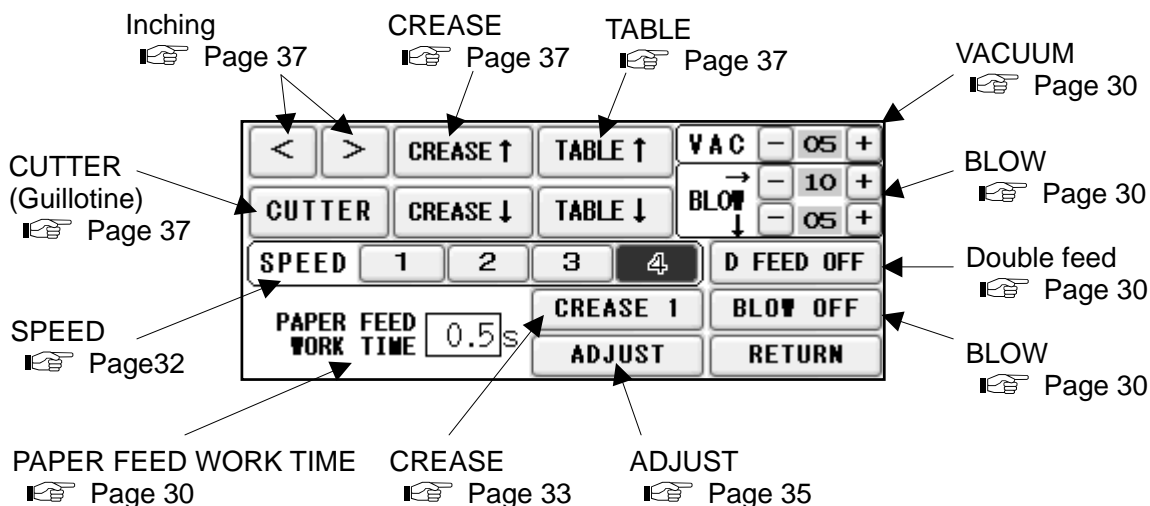

1.4 Paper weight / quality

Use suitable paper stocks which weight is 120 to 400gsm(0.005"-0.016").

These paper stocks are not suitable in use.

- Papers that has heavily electric static charged. It may cause miss-feed, double feed or paper jam.
- Papers that are more than 0.125" curled or waved. It may cause miss-feed, double feed or paper jam.
- Papers that have ink or toner not fused properly. It may cause contaminating the work and the machine.
- Papers that are too slippery. It may cause miss-feed or inaccurate results.
- Prints that are shrank, stretched or skewed inconsistently. It may cause inaccurate results.

2 Operating instructions

2.1 Lock a caster brake

2.2 Turning the power on

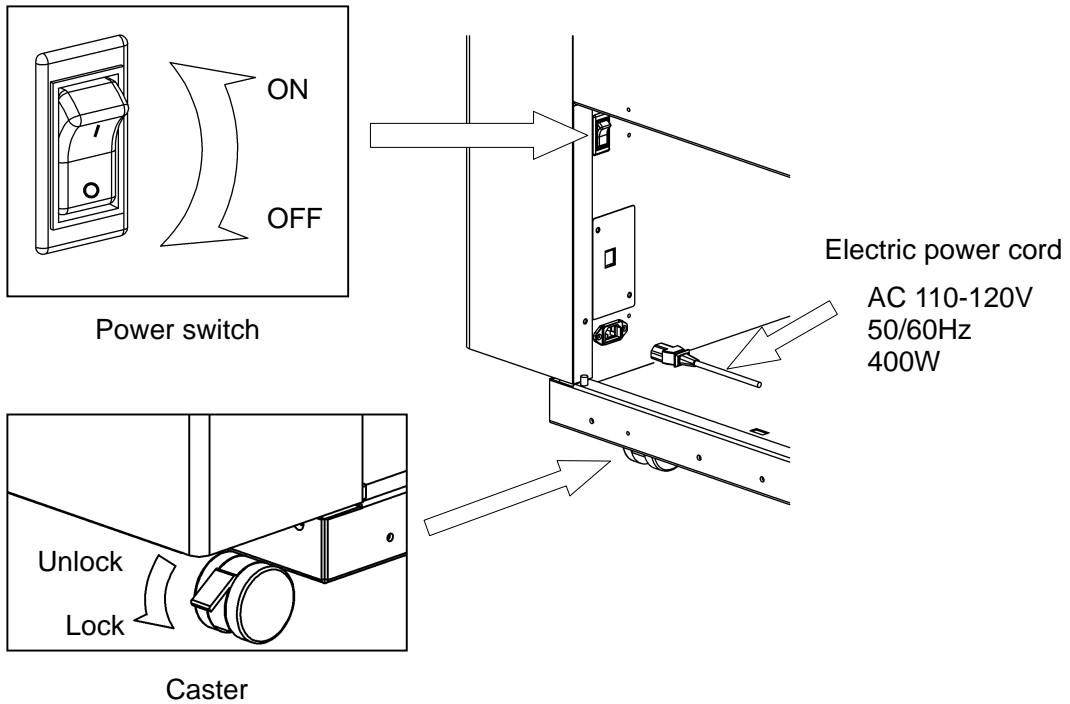

Power on



Opening screen



Home screen

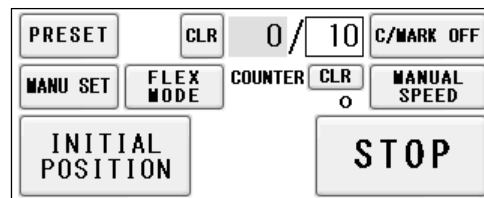

2.3 Initial position

- ① When the power turned on, the touch screen shows **INITIAL POSITION** button. Press **INITIAL POSITION** button.
- ② The slitters will move to their initial position automatically. Then the button changes to **SET**.

Home screen

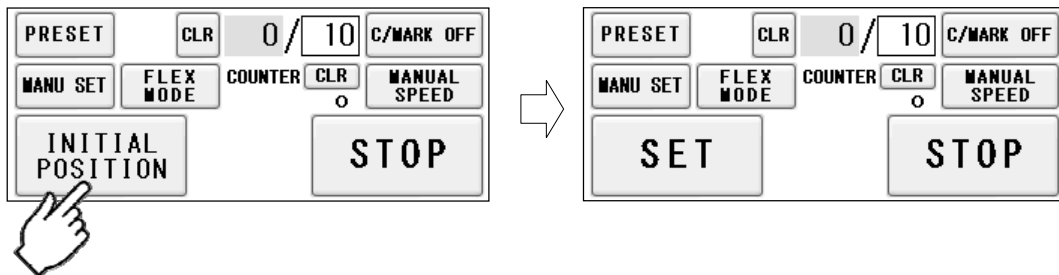

2.4 Input

- ① Enter the cut pattern.

Home screen

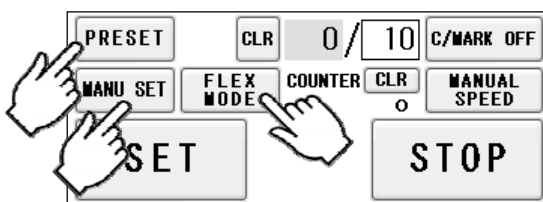

- ② Enter the number of sheets for operation.
All the sheets on the feed table will feed in case 0 is entered in Qty.

Home screen

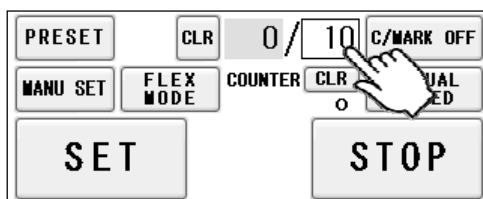

- ③ Touch the screen to have **C/MARK ON** to activate cut-mark registration.
When it is on, the machine register the cut-mark and cross cuts at proper positions even the image is drifted.

Home screen

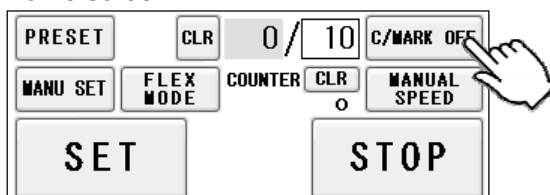

2.5 Set

- ① With a press of **SET** button, the slitters will move to the positions according to the selected cut pattern.
- ② At the same time, Feed table will move to the lower end position.
- ③ **START** button will be indicated upon all slitters are completely set.

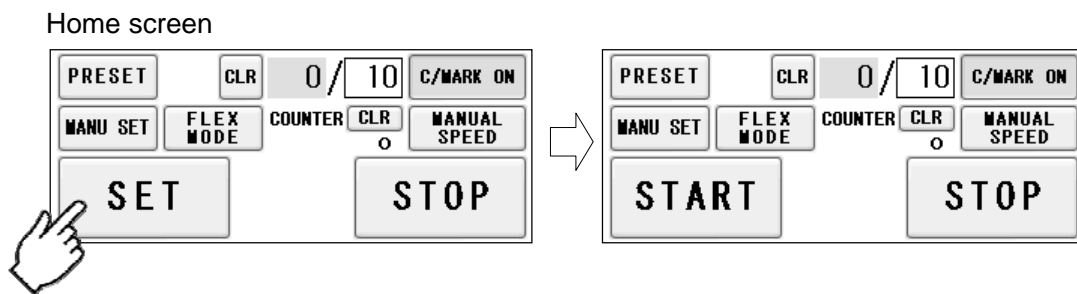

2.6 Paper setting

- ① Press the **START** button on the home screen. If the feed table is in upper position. The feed table moves down. Press **STOP** button to stop the table moving.
- ② Flip through the sheets well before you put them on the feed table.
- ③ Set the sheets on the feed table. Use the paper guide (Large) and paper guides (Small) to fix the sheets.

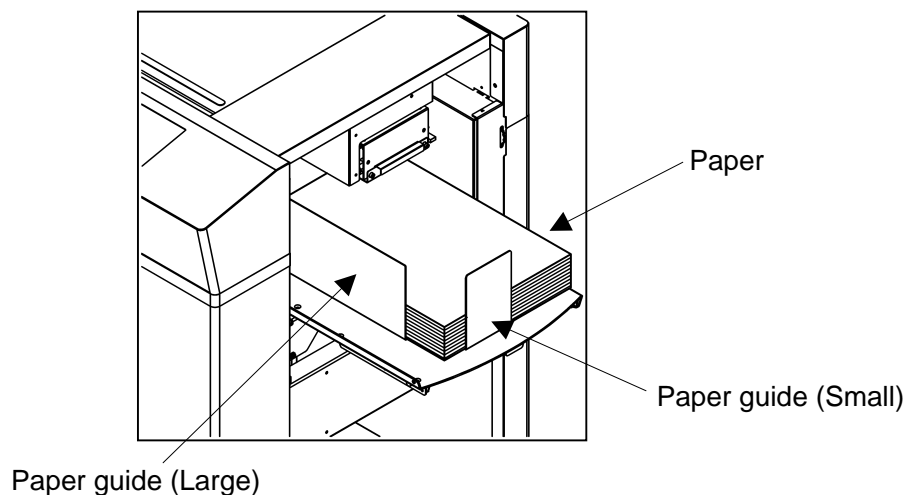
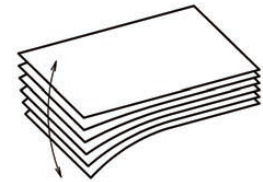

Note.

- Paper loading capacity is 3.95”.
- Make sure that the paper stack does not exceed the MAX label.
- It affects finishing accuracy if there is a gap between the side guide and the sheets.

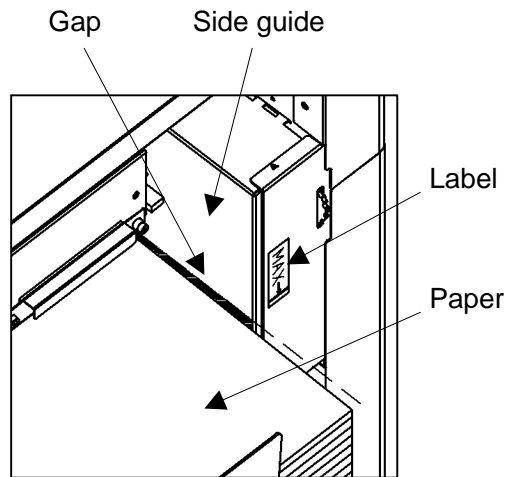

- If the print is skew on the sheets, the angle of the side guide can be adjusted.

👉 Page 33

 Warning	
	Don't put hands inside work area. May result in severe injury.

2.7 Stacker and Waste box settings

- ① Place the Waste box under the Chute.

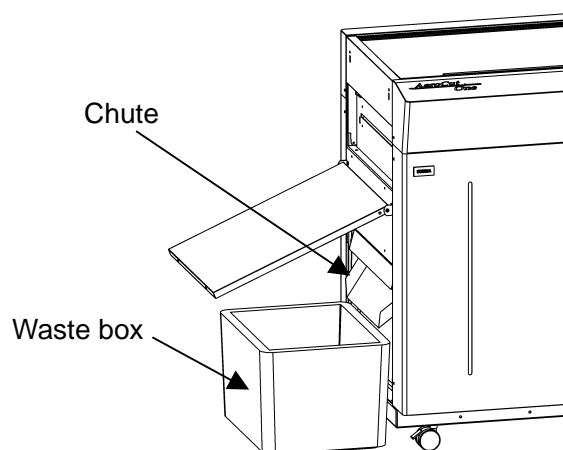

- ② Open the stacker and set the stays in the indentation of the back of the stacker at an appropriate angle to allow smooth paper ejection.
- ③ Adjust the large paper guide according to the paper size.

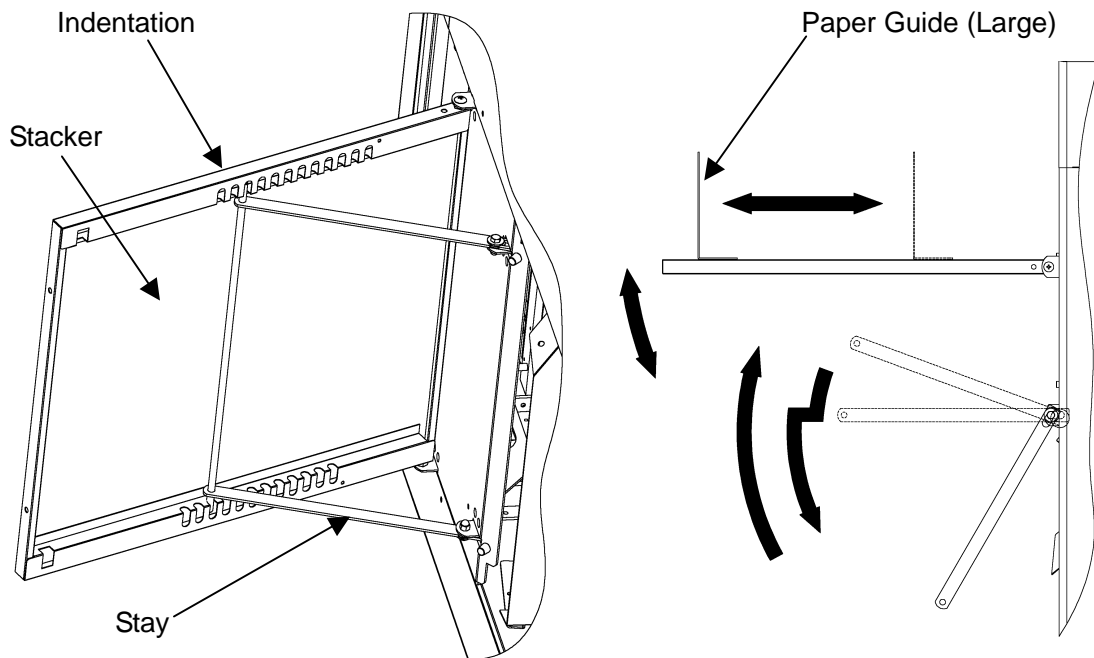

- ④ Hang the business card stacker to the Stacker panel.
- ⑤ Find the V- notch to see where to put the business card partition.
- ⑥ When it is not used, it may be hooked to the upper holes in the stacker panel.

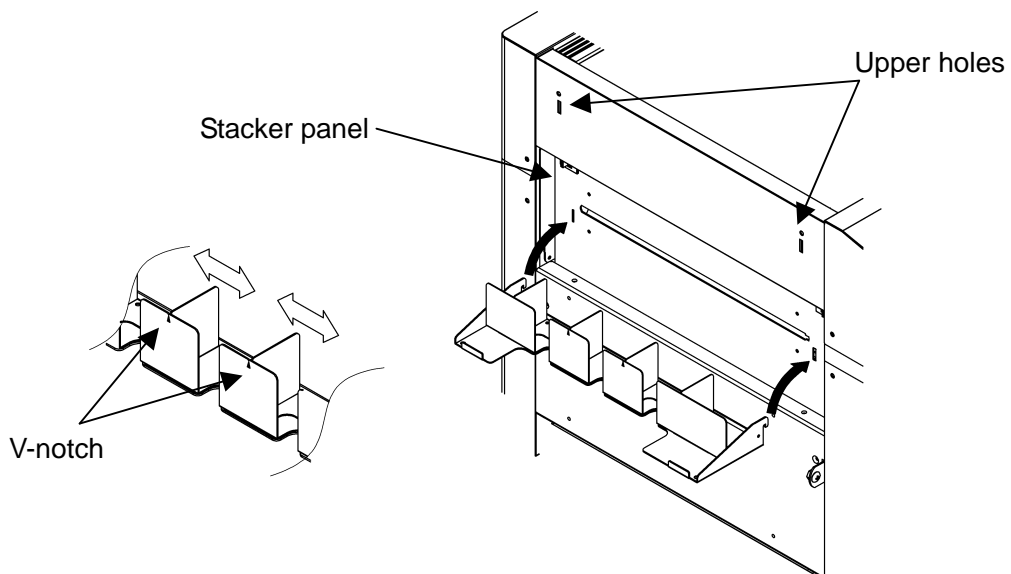

- ⑦ Change the settings of the stacker according to the cut pattern.

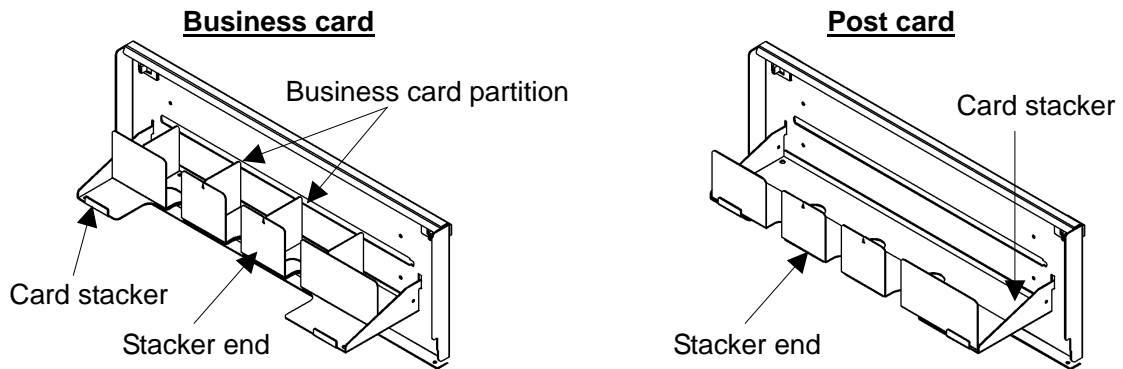

2.8 Start

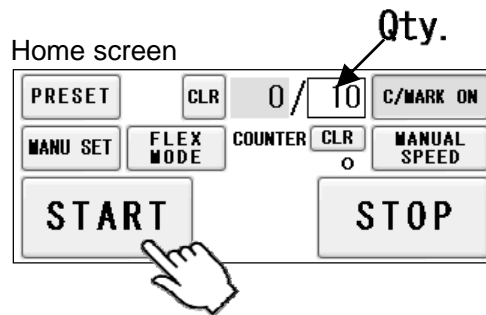

- Press **START** to start an automatic operation. The display will change to **RUNNING**.
- After processing the entered number of sheets in **Qty.**, the machine stops automatically.
- Do not open the Safety cover (☞ Page 6) while the machine is running. Machine will stop immediately.

2.9 Stop

Home screen (While Running)

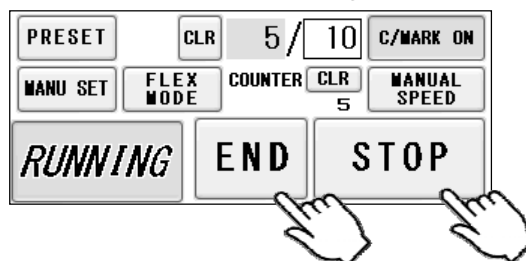

- Press **STOP** and the machine will make an EMERGENCY stop even if the operation is underway.
- Press **END** if you wish to stop the machine when the current sheet is completed.

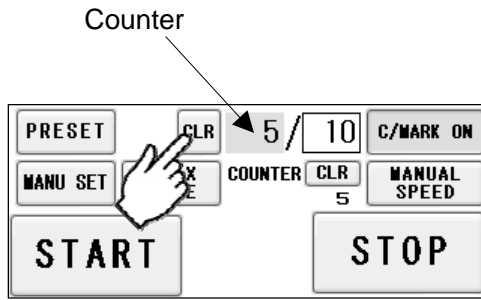

- The counter indicates the number of finished sheet when the machine is stopped with **STOP** or **END** button. Press **CLR** to reset the counter to 0.
- If paper is left in the machine, remove it by inching. (👉 Page 37)

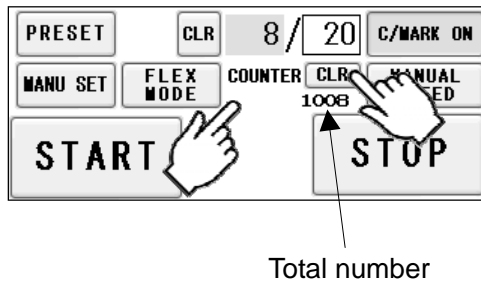

- The total number of processed sheets are counted. Press **CLR** and hold to clear the number. You can change the Total number.
- You can make a little adjustment on Total number.

2.10 Waste disposal

- Dispose the wastes in the waste box appropriately.
- Overloading wastes causes errors or a breakdown.

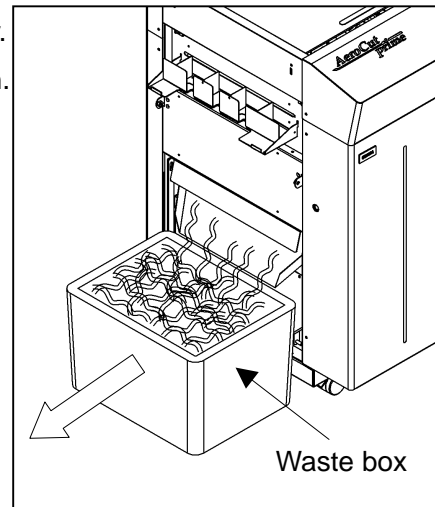

2.11 Power off

- Make sure that the machine is stopped.
- Return to the Home screen.
- Turn off the Power switch.

Home screen

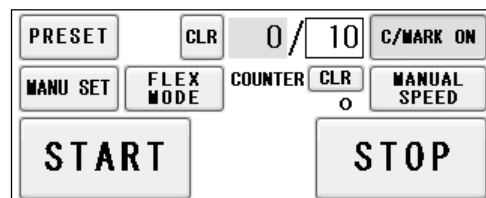

3 Cut pattern input

3.1 Outline

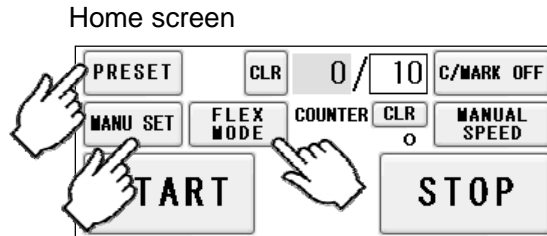

① **PRESET**

PRESET is a series of cut patterns that are already stored in the machine.

(Template)

② **MANU SET**

In MANUSET mode, user programs can be created and stored into the machine.

③ **FLEX MODE**

In FLEX MODE, you can generate user data with a lot of flexibility in layout. And also these data can be stored into the machine.

3.2 PRESET

- ① Press PRESET.

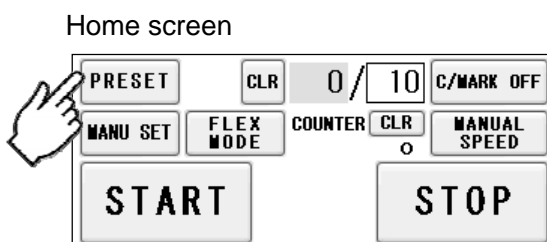

- ② Press the size of the original sheets.

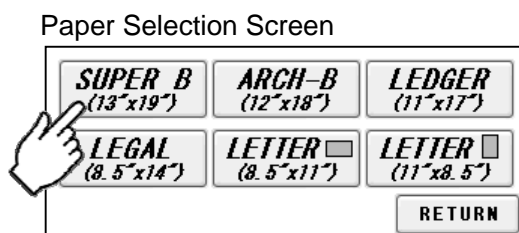



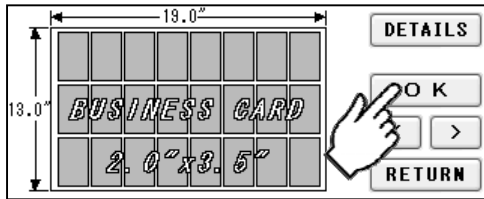

③ Select the cutting pattern.

Cutting Pattern Selection Screen

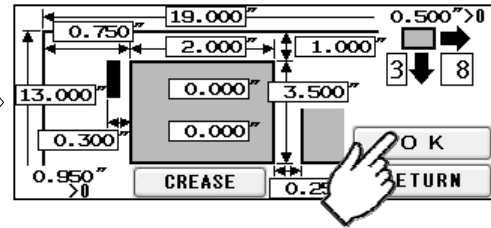

Cutting Pattern Confirmation Screen



	Cut pattern can be checked in detail and the measurements can be changed. Refer to MANUSET (☞ Page.20) for measurement setting procedures.
	Confirm the cut pattern.
	Cutting pattern switching.
	Return to the previous page.

④ The machine recalls the preset pattern and automatically returns to the home screen.

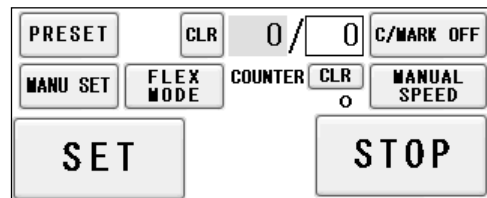
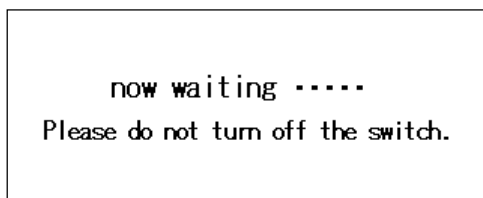

3.3 MANUSET

- ① Press MANUSET.

Home screen

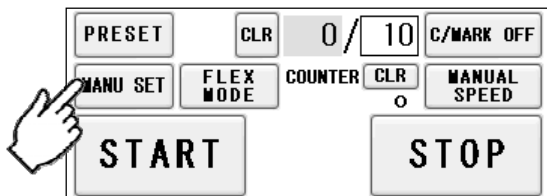

- ② The screen displays the current cut pattern.

Cutting Pattern Input Screen

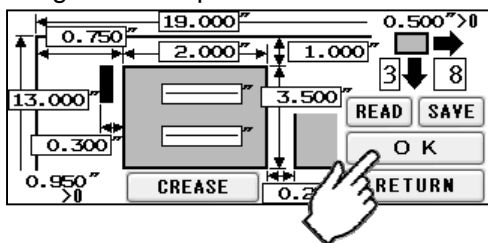

Crease Pos. Input Screen

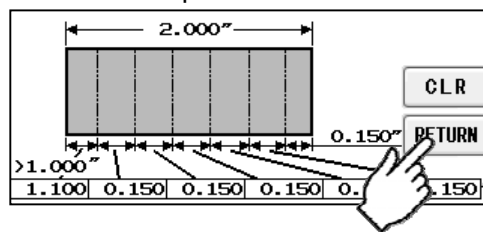

Cutting Pattern Input Screen	
READ	Move to User Program Selection Screen.
SAVE	Save Cut pattern as inputted into User Program memory.
O K	Confirm Cut pattern as inputted.
CREASE	Move to Crease Pos. Input Screen. CREASE ON will be indicated in case crease processing is given.
RETURN	Go back to Home screen without any changes.

Crease Pos. Input Screen	
CLR	All values inputted on Crease pos. input screen will be cleared.
RETURN	Confirm values as inputted and go back to Cutting Pattern Input Screen.

③ Press the number to change the value.

Measurement A-R can be customized. Measurement S-U will be calculated automatically.

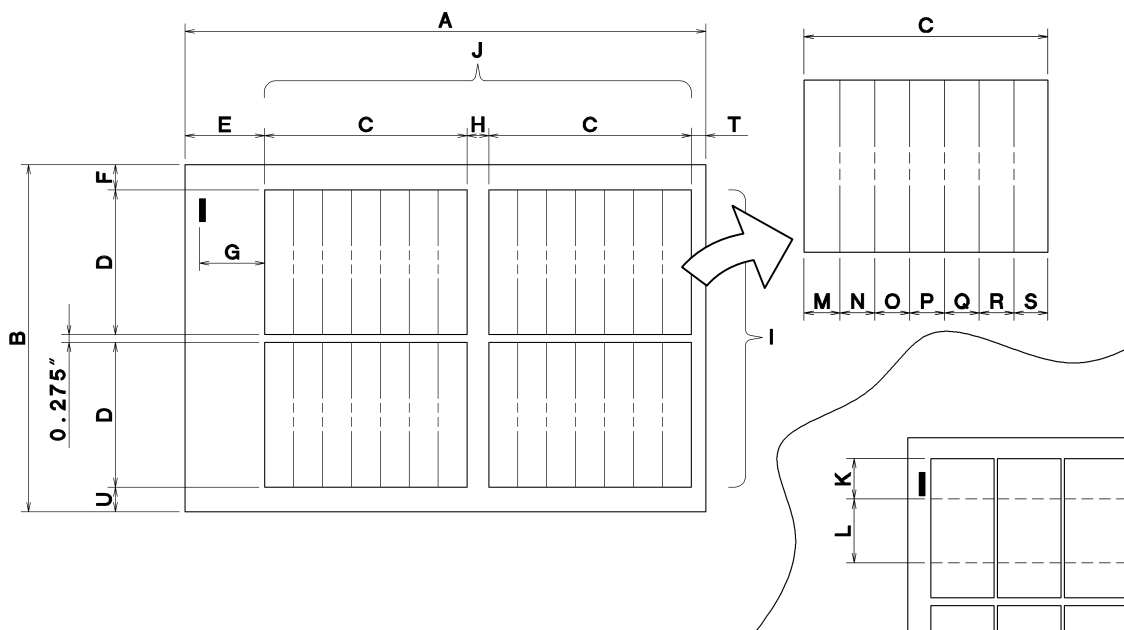
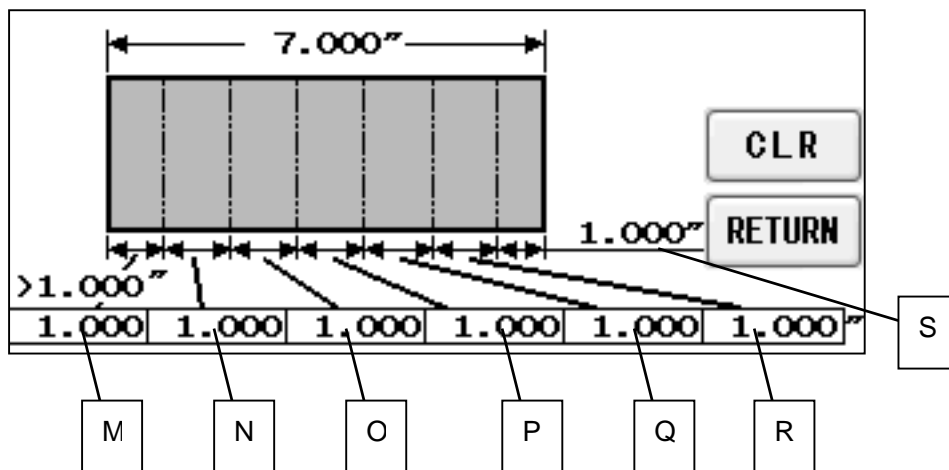
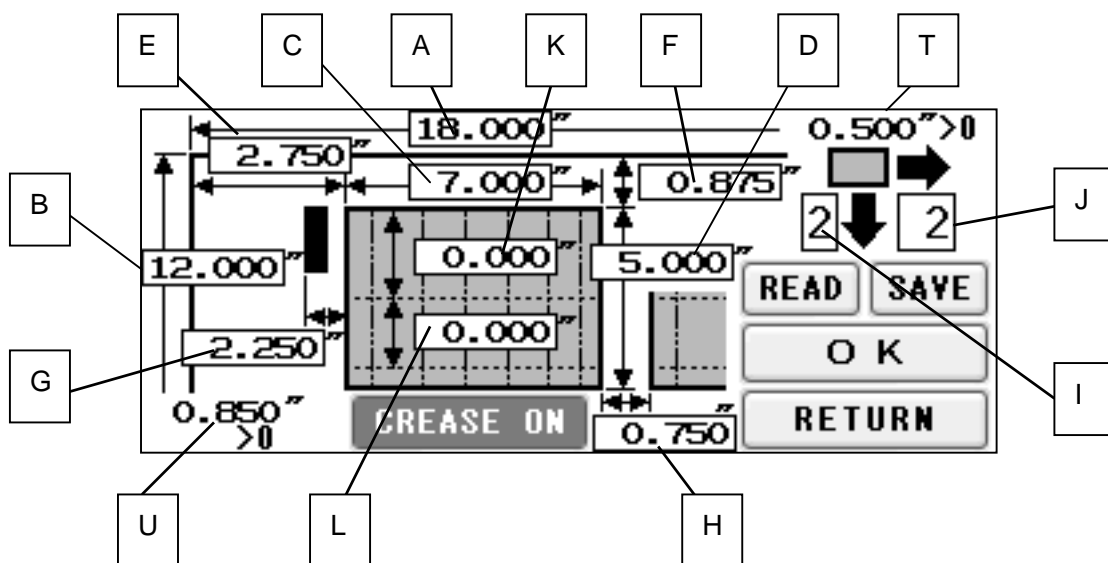

④ There are some limitations in value as shown on below image.

Front margin size [inch]
It doesn't make the first cut if 0 is entered.

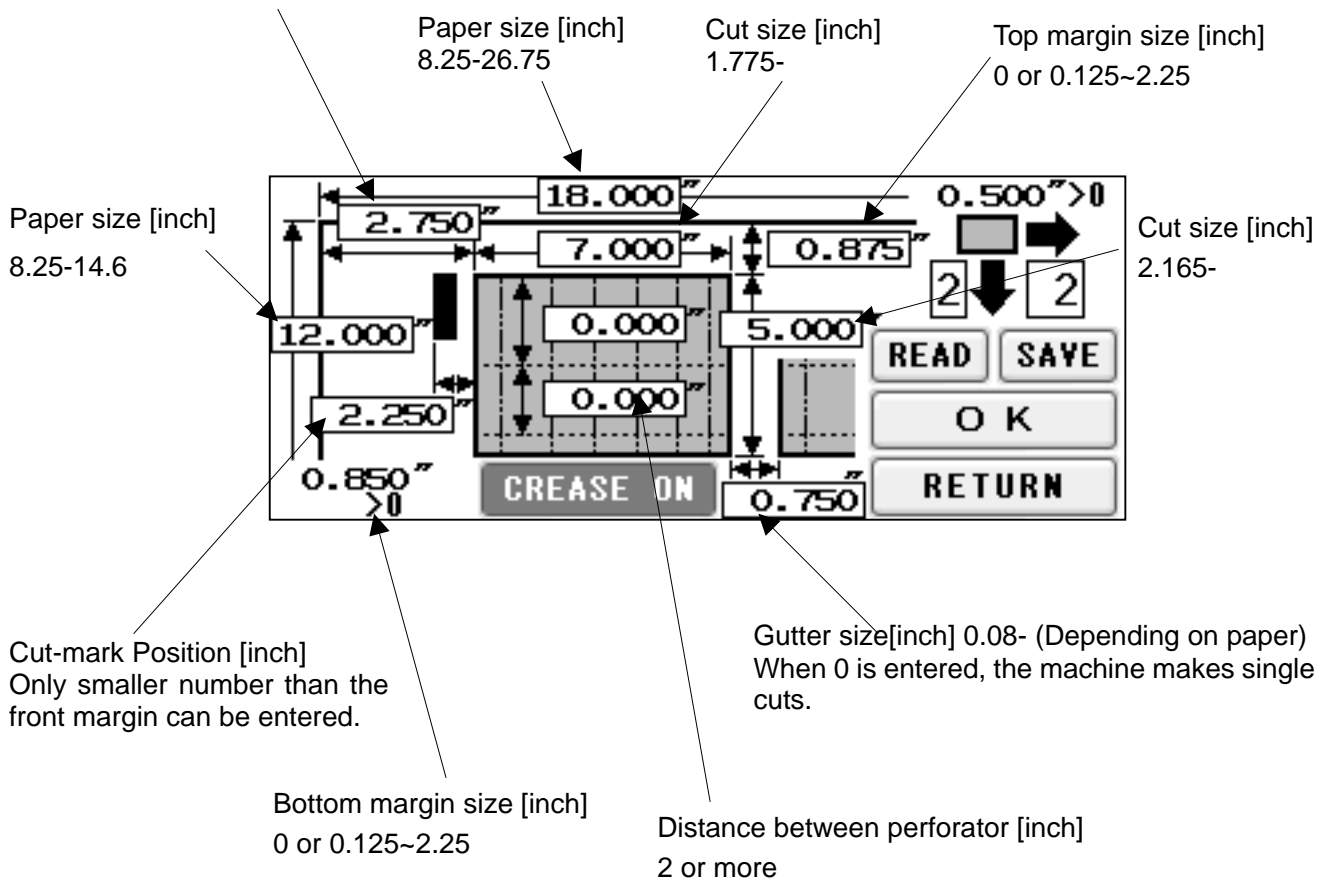

• If an error message is displayed. Page 38

3.4 FLEX MODE

- ① Press FLEX MODE.

Home screen

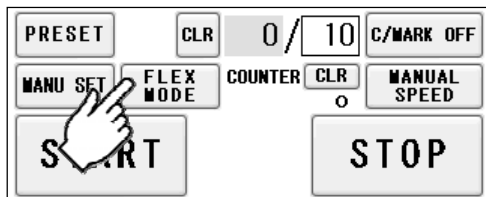

- ② FLEX mode is an operation mode where you can input up to 20 actions (cross cut, crease or perforate) per page. This allows the machine to finish jobs which MANU SET cannot finish, such as multiple sizes of cards from a page and pass through pages without any actions.

- ③ This picture on right is an example which will explain how to input values.

——— : Cut
 - - - - : Crease

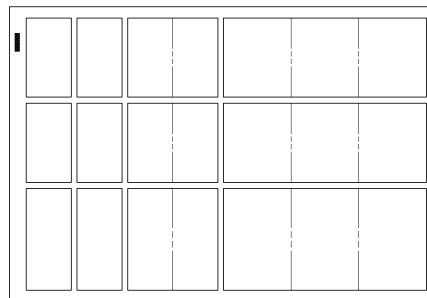

- ④ Press the number to change the value.

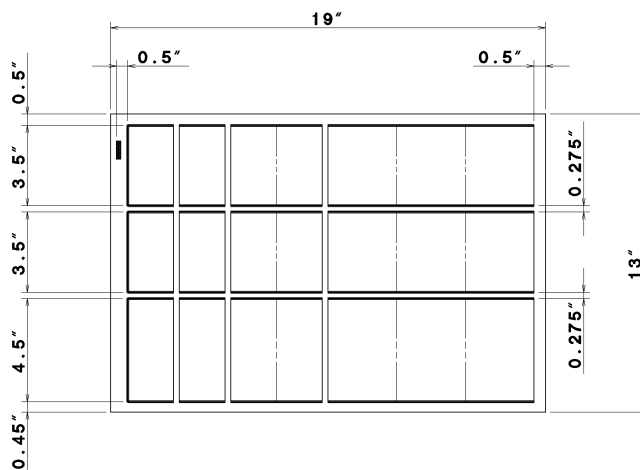
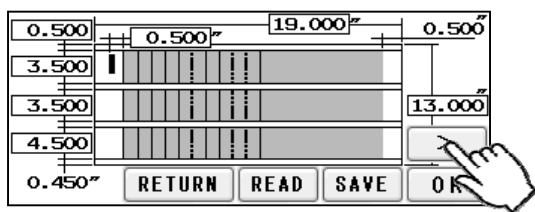

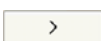
- ⑤ When data input is completed, press  to the next screen.

- ⑥ This screen allows you to input each pitch from No. 1 to No. 20. The adjacent switches are used for selecting no operation, guillotine, or creaser. Every time the switch is pressed, the selected operation changes.

: No operation : Creaser
 : Guillotine

- ⑦ If the pitch of 0.000 is input, all the pitches after that one are corrected to 0.000 (no operation).
- ⑧ Pressing **SAME PITCH** copies the No. 1 pitch and its relevant operation to No. 2 to No. 20 pitches.
- ⑨ When data input is completed, press to the next screen.

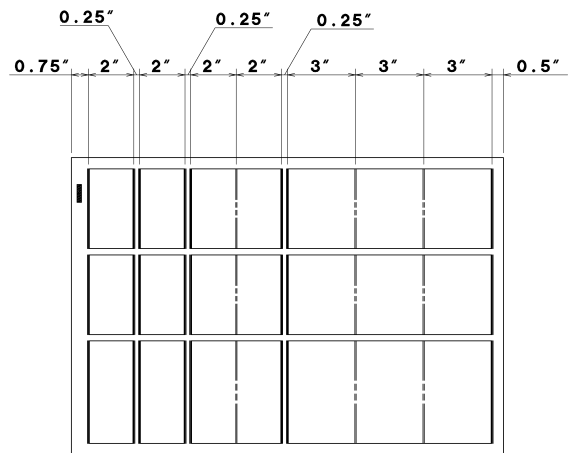
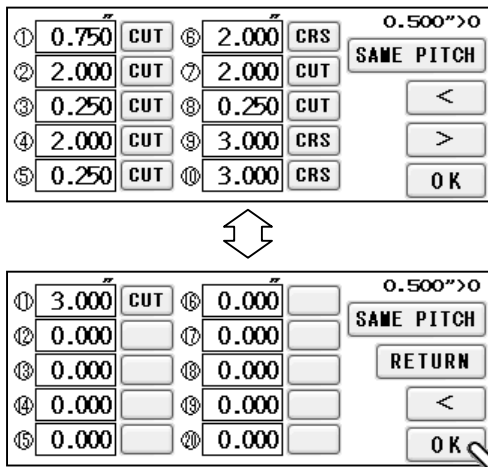

- ⑩ When data input is completed, Press to Home Screen.

3.5 SAVE / READ

- 100 of MANUSET user data can be stored.
- 60 of FLEX MODE user data can be stored.
- SAVE/READ procedures are same in each mode.

SAVE

- ① Can store the contents of the MANUSET Press the **SAVE**.

Cutting Pattern Input Screen

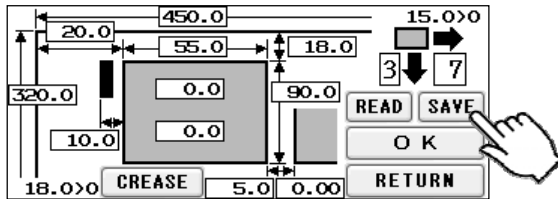

- ② Press the button in which you wish to make a registration.

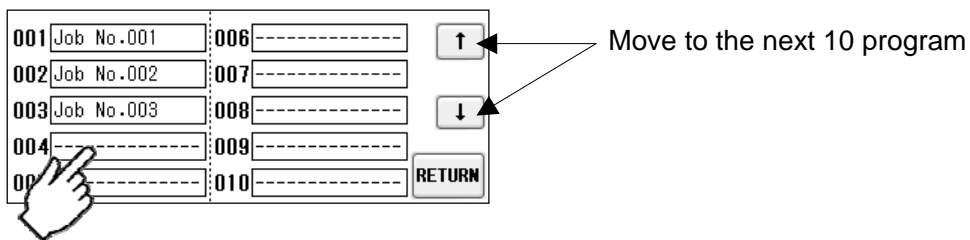

- ③ Enter the name for registration.

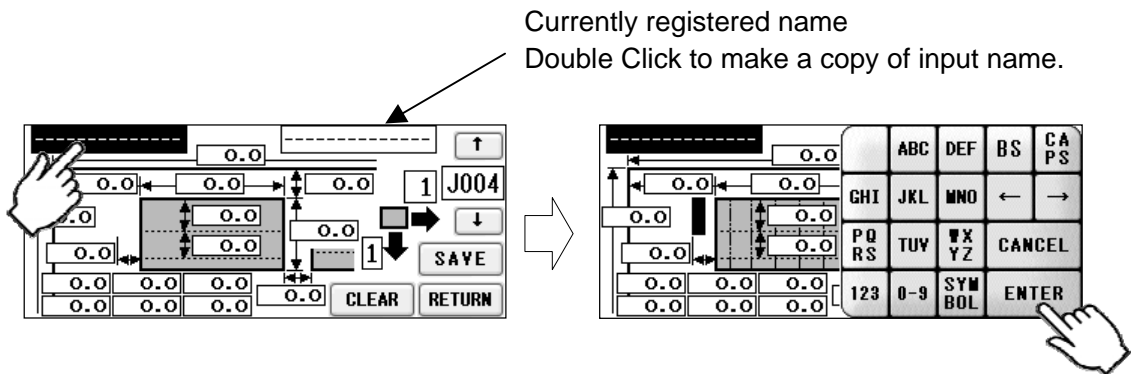

- ④ This message will be shown if **SAVE** was pressed. Then press **OVERWRITE** and save data.

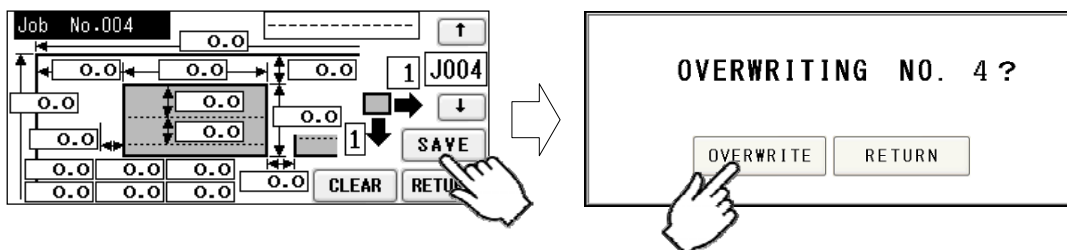

- ⑤ Saved user data can be deleted with a press of **CLEAR**.

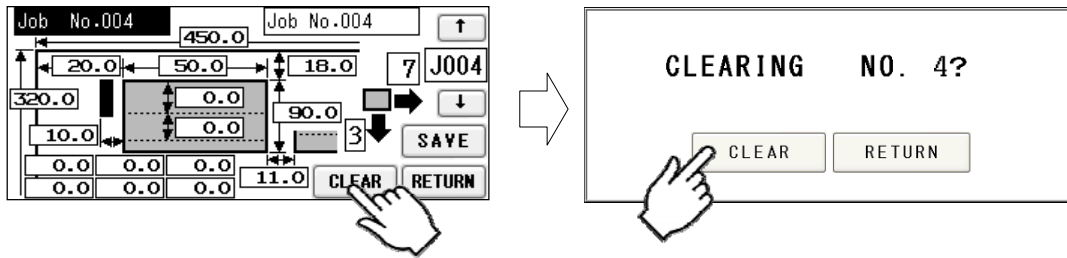

READ

- ① Can store the contents of the MANUSET Press the **READ**.

Cutting Pattern Input Screen

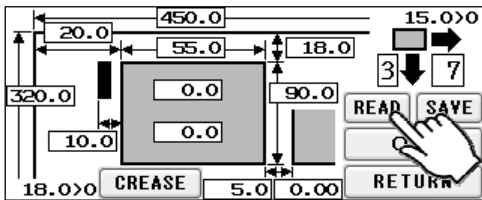

- ② Press the button of the name you wish to retrieve.

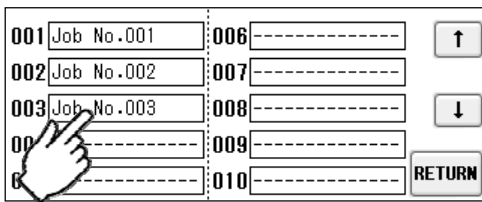

- ③ Confirm the details of the program for retrieval.
Data can be accessed with a press **OK**.

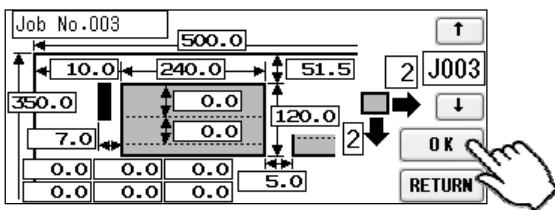

4 How to use options

4.1 How to attach the Y-perforator

- ① Remove the delivery guide.

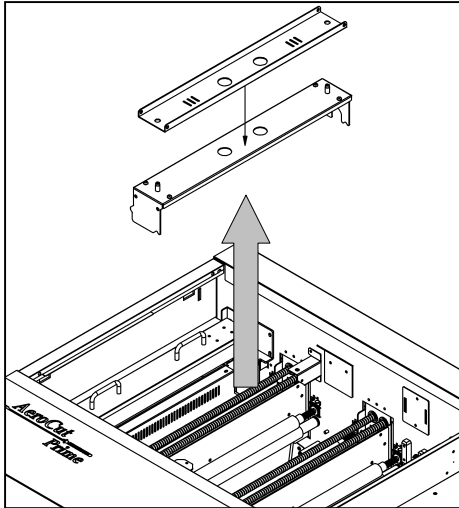

Note.

In case Perforator unit is not set in the machine, please attach the delivery guide instead in order to avoid paper jam.

- ② Attach Y-Perforator unit.

- Be sure to hold the perforator with both hands and attach it as shown in the figure.
- Fasten knobs to fix the position of the unit.

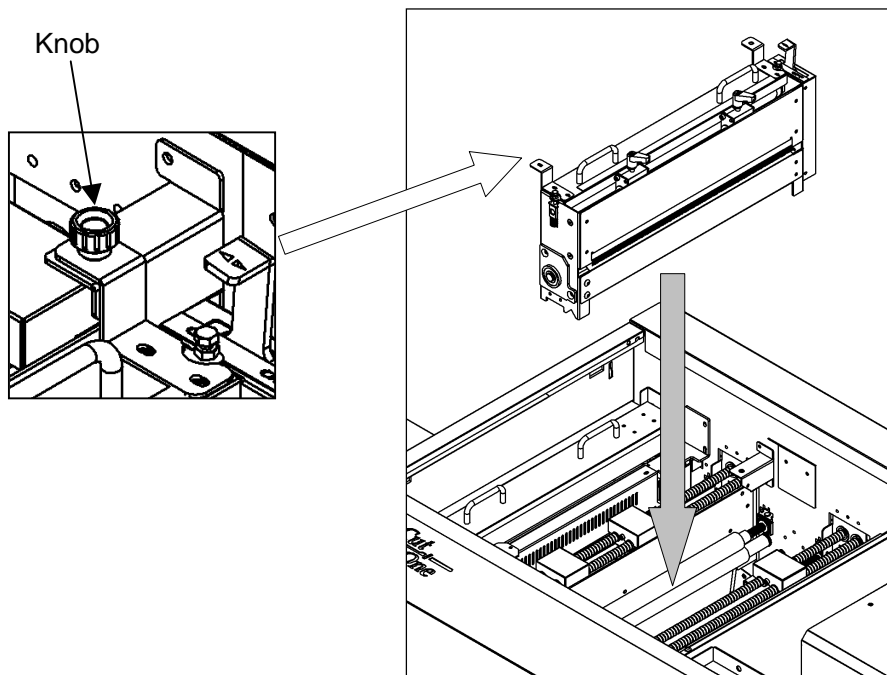

4.2 How to adjust the Y-perforation location

- ① When using the perforator, the screen will display where to fix the perforator, as shown below.

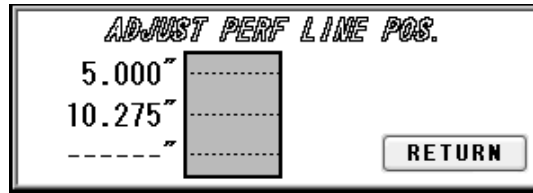

- ② If the upper blades are positioned to come into contact with the lower blades, the upper blade position can be adjusted with the perforator attached to the main body.
- ③ Loosen the clamp levers, move the perforator to the desired position based on the scale, and tighten the clamp levers firmly.

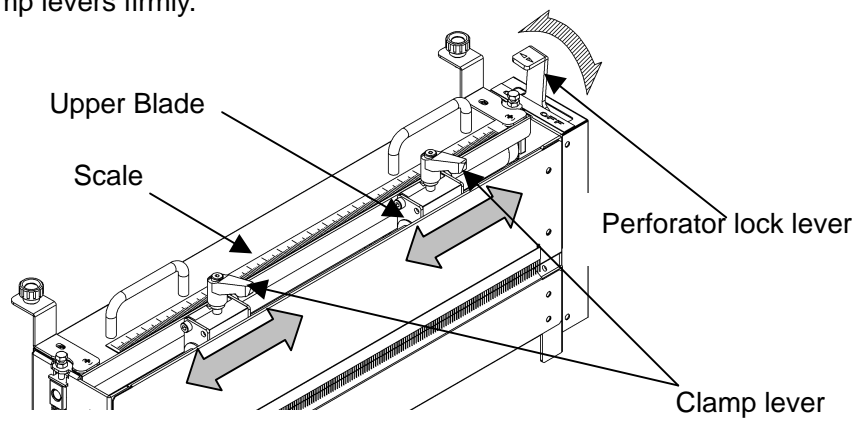

- ④ If the upper blades are not positioned to come into contact with the lower blades, remove the perforator from the main body for adjustment.
- ⑤ Loosen the two knurled head screws to remove the perforator cartridge cover.
- ⑥ Loosen the clamp levers, move the perforator to the desired position based on the scale, and tighten the clamp levers firmly.
- ⑦ Then, loosen screws with an accessory wrench and adjust the lower blade position to near the center of the upper blades.

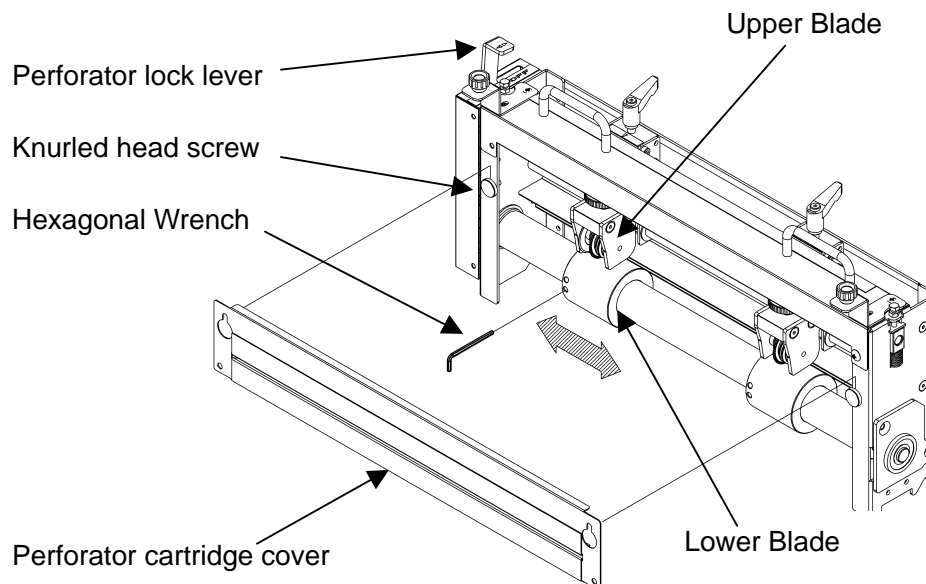

4.3 How to adjust the depth of Y-perforation

- ① Change in the paper thickness, recommend you adjust the depth of Perforation.
- ② The height of the upper blades can be individually adjusted.
- ③ Shift the perforator lock lever to the right and raise the upper blades.
- ④ Adjust a height adjustment screw in the up direction if it is cutting into too deeply, and in the down direction if not cutting into sufficiently.

Up = Shallow
Down = Deep

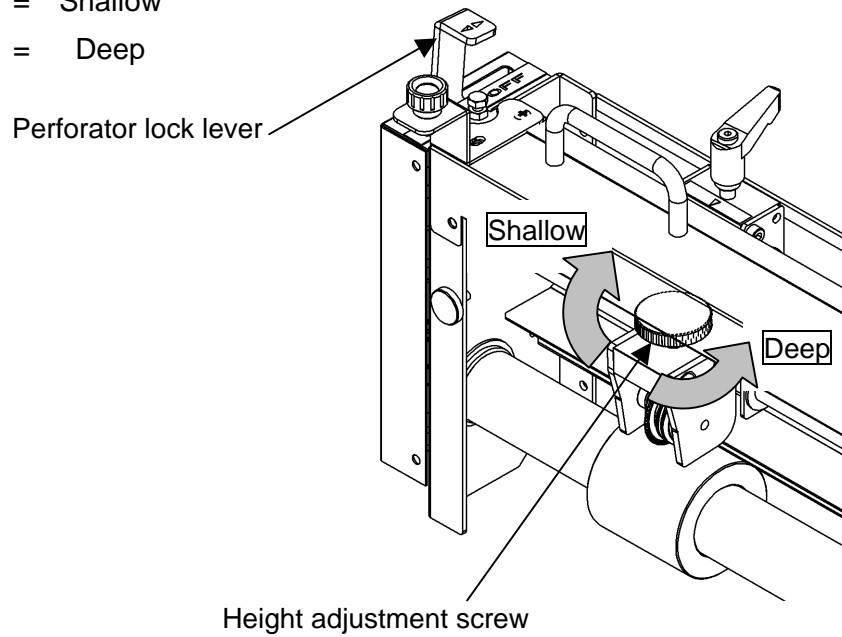

5 Adjustment

5.1 Adjustments on the paper feed section

- Adjustments are required when the machine is likely to feed double or skew.

Home screen

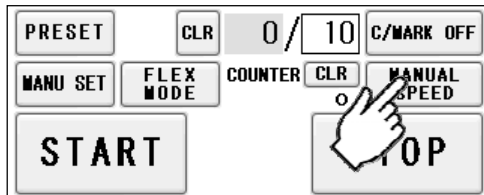

Manual speed screen

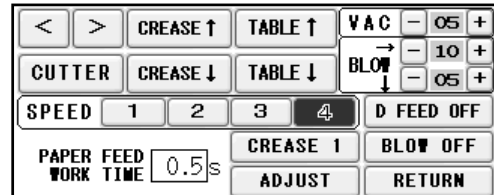

- Upper suction adjustment

「 VACUUM 」

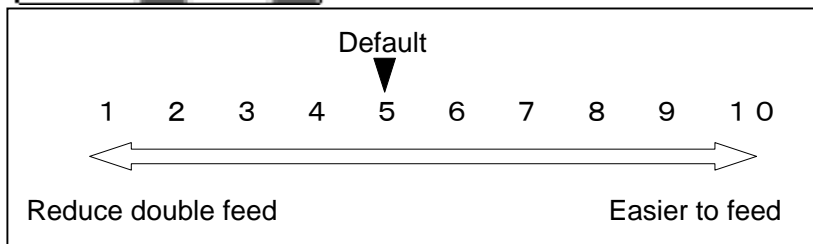

Double paper feeds may occur in case of feeding thin or low density papers. In such cases, turn down the VACUUM.

Empty feed may occur in case of feeding heavy paper. In such a case, turn up the VACUUM.

VACUUM will be turned off when the value is 0.

- Lower suction adjustment

「 BLOW - FRONT 」

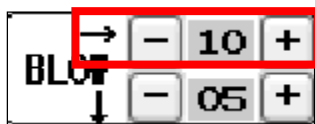

BLOW - FRONT will be turned off when the value is 0.

「 BLOW - SIDE 」

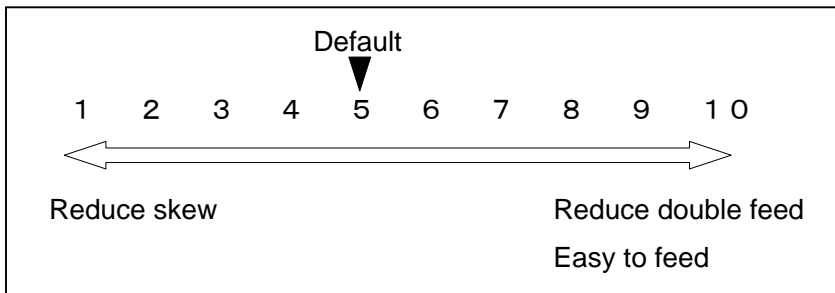
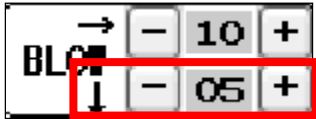

Thin paper might be bent and fed. In this case, turn down the side blower.

Empty feed may occur when paper is heavy. In such cases, turn up the blower.

Papers with statics may cause double paper feed. In such cases, turn up the blower.

BLOW- SIDE will be turned off when the value is 0.

• Air blow adjustment

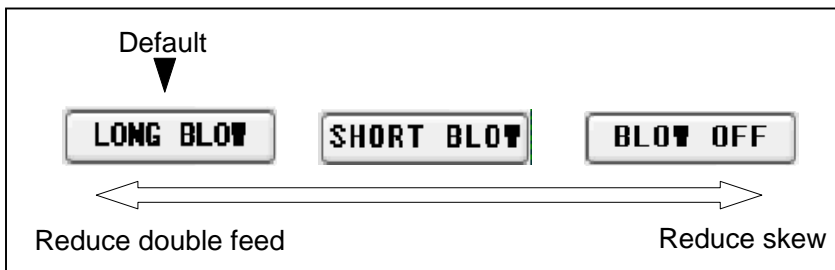

• PAPER FEED WORK TIME adjustment

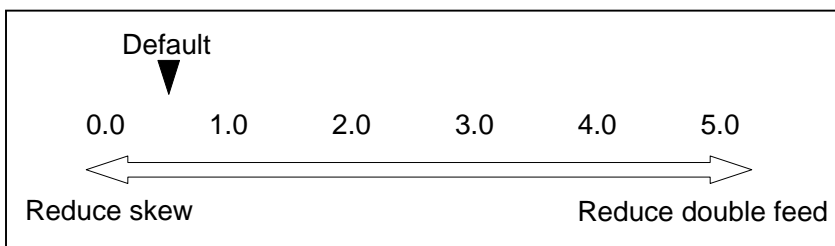

0.5 sec. is the default setting. Paper fed work time can be adjusted with a fraction of 0.1s.

- Sensitivity of Double feed sensor

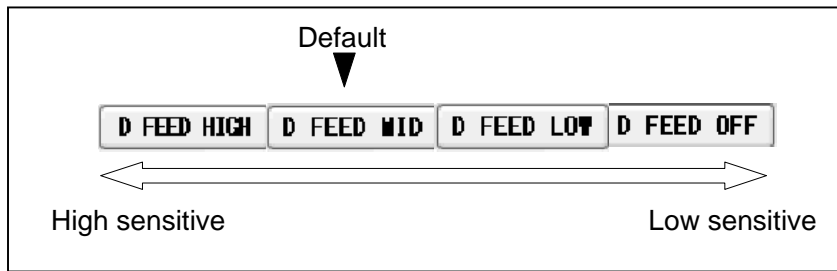

- If the machine detects double feed even with a single sheet, lower the sensitivity of the detection sensor.
- The detection sensor detects double feed by checking the edge of sheets as shown on the drawing. It is recommended not to print on the sheet edge.

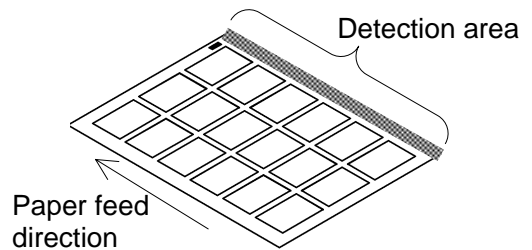

Note.

Papers which length is less than 9.843" may not be fed properly. Use the upper suction shutter to avoid empty feed.

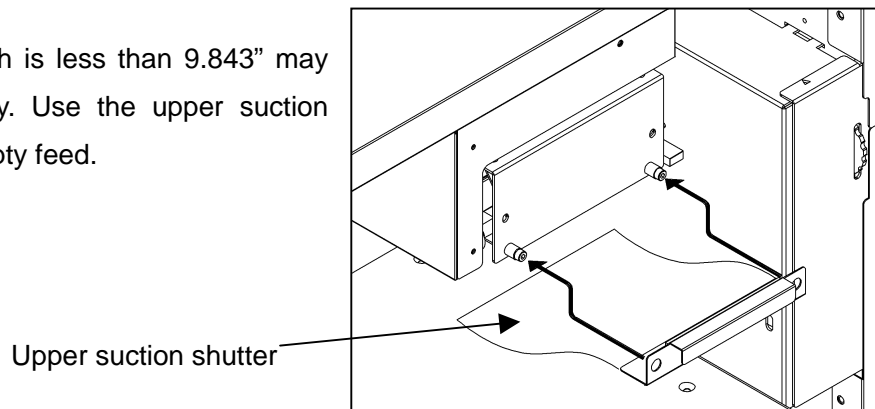

5.2 Speed change



- There are four feeding speed levels.
- The currently selected speed level is inverted to black.

5.3 Skew adjustment

- If print is skew on the sheet, the angle of the side guide can be adjusted.
- The angle of the side guide changes as the skew adjustment dial is turned.

Set the sheets again.  Page 12

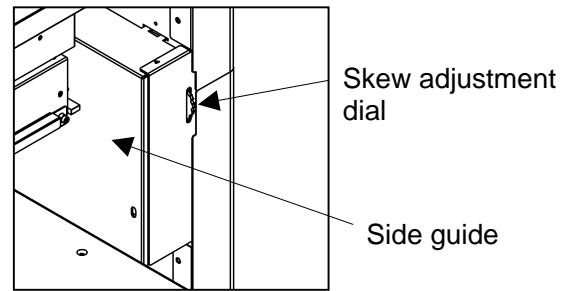

5.4 Creaser adjustment

- Turn the lever shown in the drawing below to adjust the crease depth.

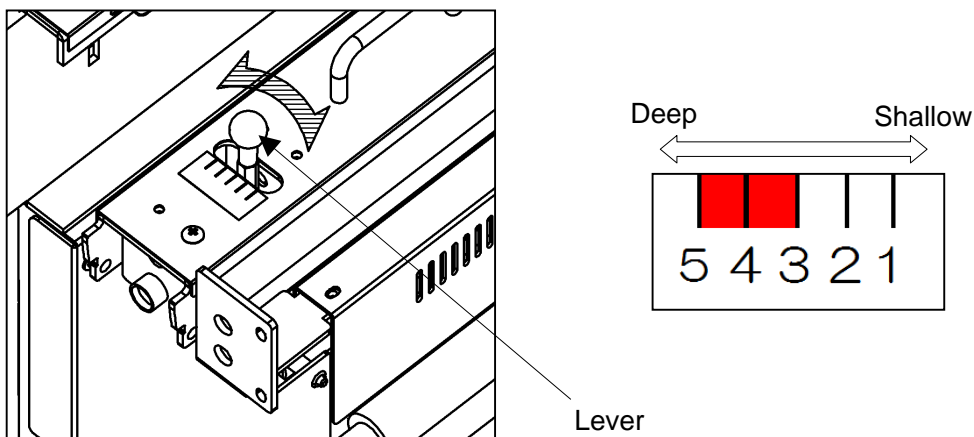

- If creasing pressure is not enough even the lever is adjusted, pressing **CREASE 1** button on MANUAL/SPEED screen and changing creasing mode to **CREASE 2** may help. **CREASE 2** mode enables the machine to cycle the creaser twice at creasing positions, which results in deeper creases.

Manual speed screen

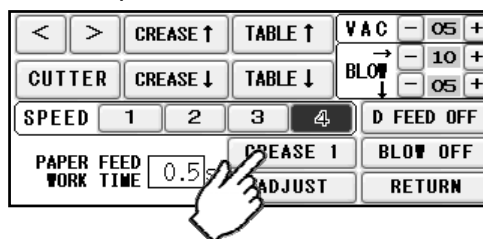

Note.

Use less than 3 in case of creasing on heavier paper than 300 gsm to avoid paper jam.

5.5 Fine adjustments on processing positions

5.5.1 In cases cutting positions don't match to image positions.

- ① Make sure the original sheets are printed correctly and consistently.
- ② Ensure that image positions correspond to inputted data.
⇒ If it does not, amend input values so that they correspond to image positions.
- ③ If the cutting positions shifts along feeding direction, input a value on micro adjustment according to below picture.

In case cutting positions shifts toward the lead edge.

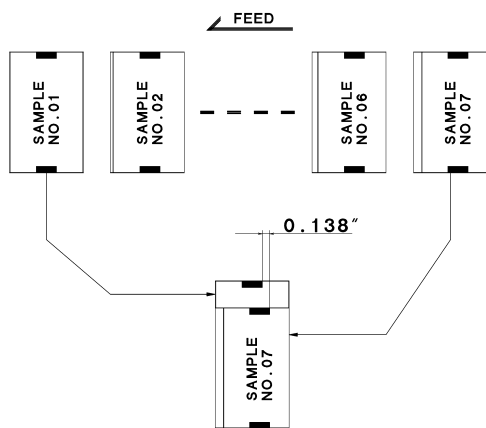

If the image position moves as the left drawing, increase the width of gutter.

Measure the difference of images between first card and the last card.

Revised values can be calculated by dividing the difference by number of gutters.

EX :

In case the gap is 0.138" and there are 6 gutters between cards, $0.138" \div 6 = 0.023"$ should be inputted.

MANU SET screen

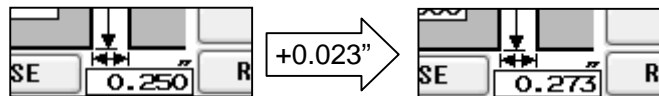

In case cutting positions shift towards the trailing edge.

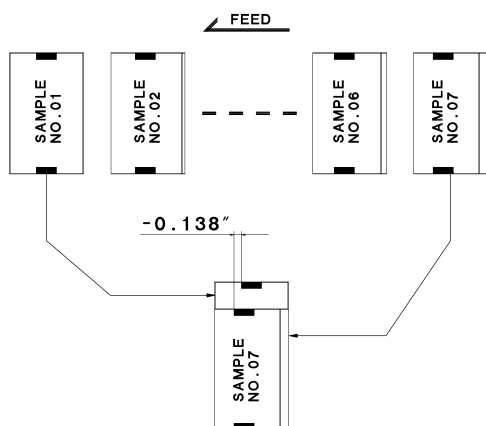

If the image position moves as the left drawing, decrease the width of gutter.

Measure the difference of image between first card and the last card.

Revised values can be calculated by dividing the difference by number of gutters.

EX :

In case the gap is -0.138" and there are 6 gutters between cards, $-0.138 \div 6 = -0.023"$ should be inputted.

MANU SET screen

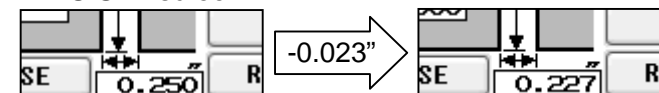

5.5.2 If the cut measurement does not match the input value

If the actual size and measurements of output differs from input values, calibrate the machine via ADJUST screen.

Manual speed screen

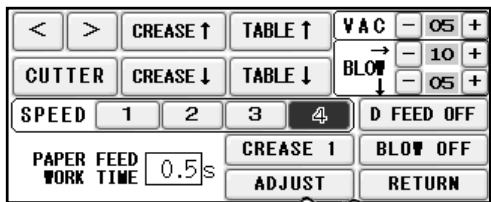

ADJUST screen

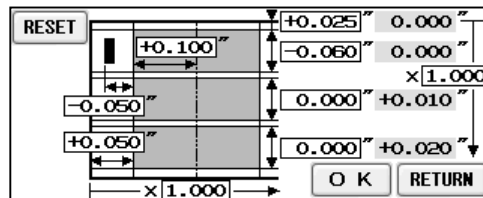

RESET	Reset the machine to the factory setting, all the adjusted values will be 0.
OK	Save the adjusted values and go back to Manual speed Screen
RETURN	Go back to manual speed Screen without making any changes.

- ① In cases the width of a card or a top margin is different from inputted values, Input differences between inputted values and actual sizes of outputs into A,B,C and D.

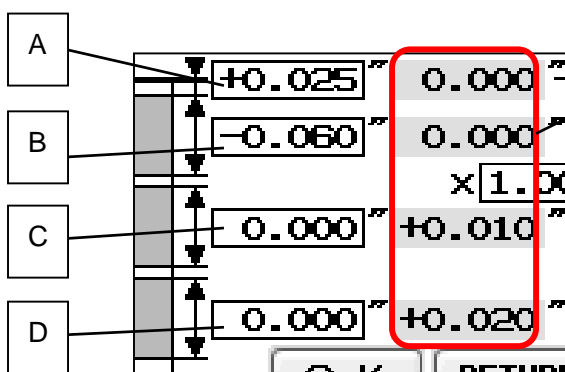

Total measurement that has been changed A, B, C, and D.

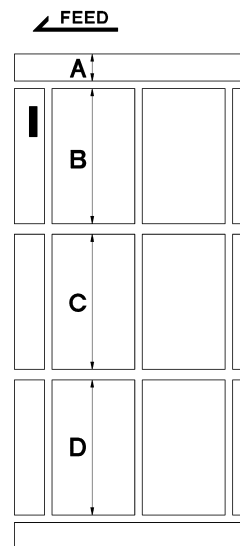

EX:

If the input value is 3.500" and cut measurement is 3.560", input -0.060.

If the input value is 0.200" and cut measurement is 0.175", input +0.025.

※ : If you press OK after you input values into A, B, C and D, those values will be added to each total measurements which are circled on the image below. Then, A, B, C and D will be reset to 0.000. You can change the measurement by 0.002". Each adjustment should be within ± 0.080 " at one time. If the gap is more than ± 0.080 ", repeat the process until the desired measurement is reached.

② In case the length of leading edge is wrong:

With cut mark

Input the difference between inputted value and actual measurement into E.

EX:

In case input value is 0.400" and cut measurement is 0.450", input -0.050 to E.

(You can input ±0.400" at the most)

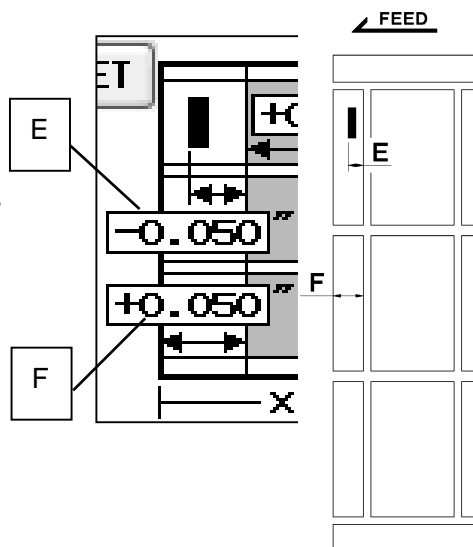

Without cut mark

Input the difference between inputted value and actual measurement into F.

EX:

In case input value is 0.600" and cut measurement is 0.550", input +0.050 to F.

(You can input ±0.400" at the most)

③ In case creasing position is incorrect

Input the difference between inputted value and actual creasing position into J.

EX:

In case input value is 2.000" and the actual creasing position is 1.900" length, input +0.100 to J.

(You can input ±0.400" at the most)

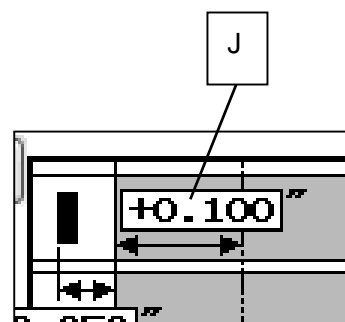

④ Others

In case you amend the value according to expansion or contraction of printing.

Input magnification into L if the printing is stretching to the feed direction.

Input magnification into M if the printing is stretching to the width direction.

Please note that changing magnifications results in changing actual measurements of outputs.

EX:

If printing should be 4.000" width, but actual printing is 4.080", input 0.980 (4.00/4.08) into L.

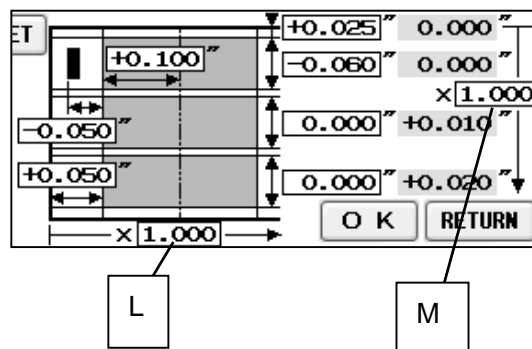

("L" must be from 0.500 times to 2.000 times and "M" must be from 0.800 times to 1.200times)

6 Manual control





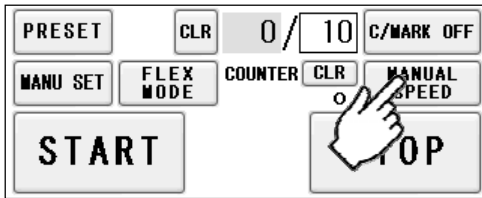

6.1 Manual control screen

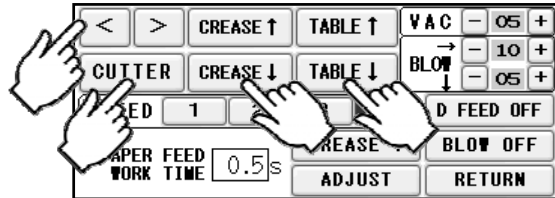
Home screen





Manual speed screen



	Feed roller will rotate. Inching.
	Feed roller will rotate in reverse. Inching.
	Guillotine will move once.
 	Crease will move.
 	Feed table will move.

6.2 Paper jam

- ① Enter Manual speed screen, press   buttons to inch the rollers forward / backward and remove the jammed paper.
- ② If paper is stuck around the guillotine section, press CUTTER to cycle the guillotine to chop jammed paper.

Manual speed screen

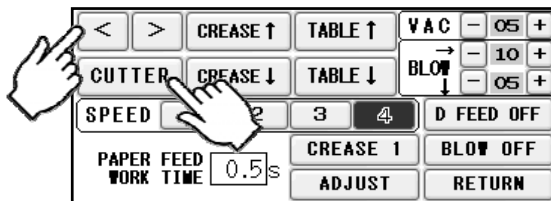

7 Error messages

1.



Cover Open error

Safety cover (👉 Page 6) might be open.

Make sure to close the Safety cover closed.

2.



Timeout error 1

Paper was not fed within a set time period.

Check the paper feeder.

3.



Timeout error 2

Paper did not pass through within a set time period.

Remove the paper remaining inside the machine.

4.



Double feed error

Check the paper or paper path.

5.



Cut-mark error

Cut-mark was unable to be detected. Check the cut mark.

Eject the paper inside the machine.

Note.

Cut-mark sensor detects the black mark by infrared light. Some types of toner or ink may reflect the infrared light and cause the sensor not reading the cut-mark. Please inactivate the cut-mark registration in such cases.

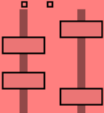
- | | | |
|-----|---|--|
| 6. | <p>CUT PAPER JAMMED !!
 REMOVE JAMMED PAPER.
 <input type="button" value="RETURN"/> <input type="button" value="<"/> <input type="button" value=">"/></p> | <p><u>Cut Paper Jammed error 1</u>
 Paper remains inside the machine.
 Remove the paper.</p> |
| 7. | <p>CUT PAPER JAMMED !!
 REMOVE JAMMED PAPER.
 OR CLEAN THE REFLECTOR
 UNDER THE STOP SENSOR.
 <input type="button" value="RETURN"/> <input type="button" value="<"/> <input type="button" value=">"/></p> | <p><u>Cut Paper Jammed error 2</u>
 Paper remains inside the machine.
 Remove the paper.</p> |
| 8. | <p>OVERLOADED !!
 CHECK
 KNIFE or GREASER UNIT !!
 <input type="button" value="RETURN"/> <input type="button" value="<"/> <input type="button" value=">"/></p> | <p><u>Overload error 1</u>
 Cutting or creasing did not complete
 within a set time period.
 Remove the paper remaining inside the
 machine.</p> |
| 9. | <p>OVERLOADED !!
 CHECK PAPER FEED TABLE !!
 <input type="button" value="RETURN"/></p> | <p><u>Overload error 2</u>
 An overloading error occurred at the
 feed table.
 Check the feed table.</p> |
| 10. | <p>OVERLOADED !!
 CHECK SLITTER UNITS !!
 <input type="button" value="RETURN"/> </p> | <p><u>Overload error 3</u>
 An overloading error occurred at the
 slitter.
 Check the blinking slitter.</p> |
| 11. | <p><i>Data are not updated!!</i>
 <input type="button" value="OK"/> <input type="button" value="RETURN"/></p> | <p><u>Update message</u>
 This error message appears as a
 warning when proceeding to another
 screen without saving the corrected
 dimensions in the MANU SET or FLEX
 MODE screen. Press <input type="button" value="OK"/> if you want to
 proceed to the other screen; otherwise,
 press <input type="button" value="RETURN"/>.</p> |
| 12. | <p>COMMUNICATIONS ERROR!!
 Cut off the power supply!
 ERROR CODE: —1</p> | <p><u>Communication error</u>
 Communication with the touch panel is
 not possible.
 Turn off the power, and turn it on again
 after 5 seconds or longer.</p> |

13.



Servo error

Servo motor error detected. Turn off the power, and turn it on again after 5 seconds or longer.

14.

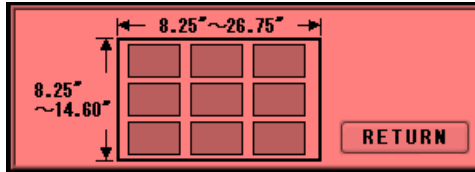

Paper size error

Correct the paper size to fit in the value range below.

15.

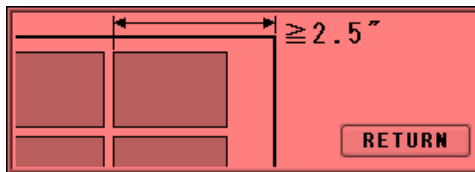

Final cutting measurement error

Correct the final cutting measurement to exceed the value specified below.

16.

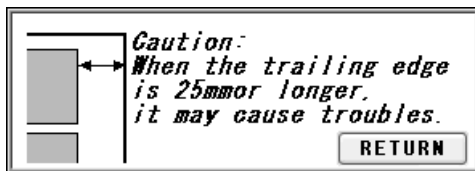

Back margin warning

When the trailing edge is 1.000" or longer, it may cause troubles.

17.

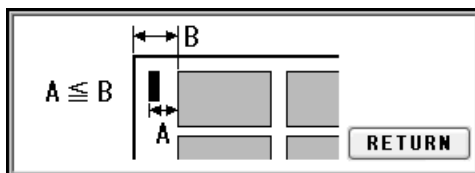

Leading edge margin and cut mark margin warning

Correct the measurement so that the leading margin becomes larger than the cut mark margin.

18.

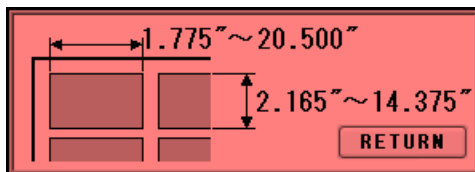

Cutting measurement error

Correct the cutting measurement to fit in the value range below.

The maximum value is subject to change depending on the entered paper size.

19.



Crease front margin error

Correct the crease front margin to exceed the value specified below.

20.

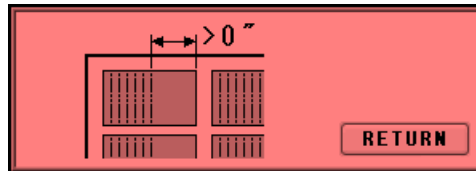

Crease back margin error

Correct the crease back margin to exceed the value specified below.

21.

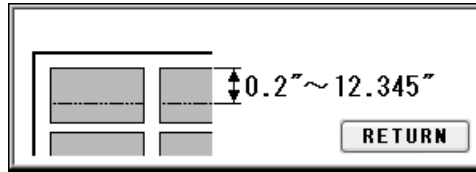

Perforation location warning

Correct the perforation location to fit in the value range below. The maximum value is subject to change depending on the entered paper size.

22.

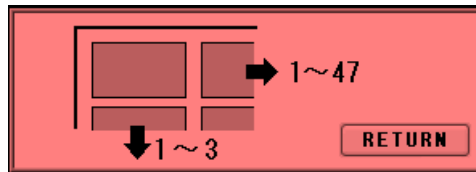

Cut piece number error

Correct the number of cut pieces to be in the value range below.

The maximum number of pieces is subject to change depending on the operation.

23.

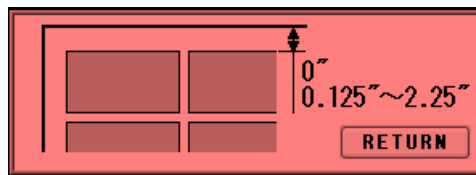

Top margin error

Correct the top margin to fit in the value range below.

24.

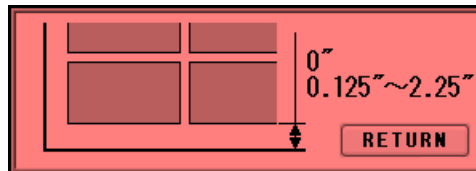

Bottom margin error

Correct the bottom margin to fit in the value range below.

25.

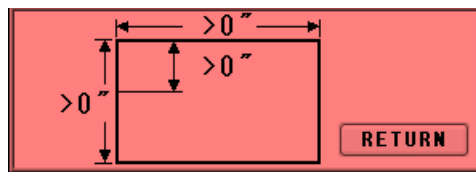

FLEX MODE input error 1

This error results when the three input values shown in the following figure are "0" or lower at FLEX MODE time.

26.



FLEX MODE input error 2

Slitter units positioning error.

Slitter position is out of valid range. Check paper size and input data.

27.

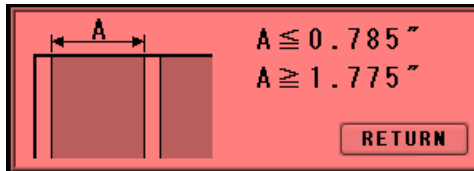

FLEX MODE input error 3

Make sure for the first cut line must be 0.785" or shorter from the edge of the paper. If you want to cut off 0.785" or more, please cut off 0.785" or less at first and then cut off again and again. If you try to move the slitter cut line at 1.85" or more position, the slit will be ejected on Paper ejection table instead of waste box.

28.

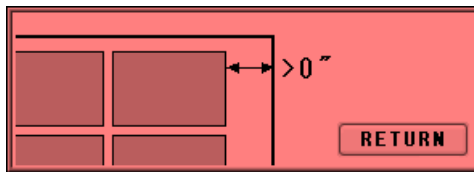

FLEX MODE input error 4

Back margin error.
Correct the back margin to fit in the value specified below.

29.



Guillotine error

The cutter blade has moved and is staying at lower position.
Move the cutter to top dead center.

30.



Crease error

The creaser has moved and staying at upper position.
Move the creaser to bottom dead center.

8 Troubleshooting

1. Papers are not fed well.

- Turn up Upper suction (👉 Page 30)
- Turn up Side blow (👉 Page 30)
- Shorten the PAPER FEED WORK TIME. i.e. less than 1.0 (👉 Page 30)
- Check if the paper guides on the feed table hold sheets too tight.
- Make sure that the paper edges are not curled or waved.
- Make sure that the papers are not heavily electric static charged.

2. The machine feeds double-sheets.

- Turn down Upper suction (👉 Page 30)
- Turn up Lower suction (👉 Page 30)
- Turn up Side blow (👉 Page 30)
- Make sure that the papers are not heavily electric static charged.
- Lengthen the PAPER FEED WORK TIME. i.e. 2.0 (👉 Page 30)

3. The machine doesn't detect double-feed properly.

- The machine detects the density of the first fed sheet and compares the density of the next sheet to the first one. Therefore, the machine cannot detect double-feed when it occurs with the first fed sheet.
- Adjust the sensitivity of the double-feed detection sensor. (👉 Page 30)
- The detection sensor detects double feed by checking the edge of sheets as shown on the drawing. It is recommended not to print on the sheet edge. (👉 Page 30)

4. The machine detects double-feed mistakenly.

- Adjust the sensitivity of the double-feed detection sensor. (👉 Page 30)
- The detection sensor detects double feed by checking the edge of sheets as shown on the drawing. It is recommended not to print on the sheet edge. (👉 Page 30)

5. Cut skewing

- ① Make sure that the stock is put on the feed table correctly. (👉 Page 12)
- ② Check whether the skewings are consistent or inconsistent.

If skewings are consistent :

- + Make the skewing adjust via the skew adjustment dial. (👉 Page 33)
- + Set the paper guides without play.

Do not set them too tight as the sheet may not be fed well.

If skewings are inconsistent :

- + Turn down Side blow. (👉 Page 30)
- + Shorten the PAPER FEED WORK TIME. i.e. less than 1.0 (👉 Page 30)
- + Make sure that the sheets are printed consistently and aligned well.

6. Paper jam often occurs.

- Make sure that papers, paper strips or paper dusts not remain inside of the machine.
- Check the conditions of the paper stock. (👉 Page 9)

9 Product specifications

Specifications	
Slitter	4 sets (6 slitter blades)
Guillotine	1 set
Creser	1 set
Y perforator	2 set(Depends on configuration)
Maximum paper size	14.6" x 26.75"
Minimum paper size	8.25" x 8.25"
Minimum work size	2.165" x 1.775"
Paper weight	120-400g/m ² Depending on paper
Maximum paper curl size	±0.125"
Paper type	Offset, Coat, UVcoat, Glossy, Laminate Depending on paper
Paper feeding method	Tri-suction upper belt feeding mechanism
Input tray capacity	MAX4.000"
Speed	8.8 sheets per minute (21 business cards from SRA3)
Machine dimensions [inch]	W42.2"x D28.2"x H42.2" (Occupancy area: W76.8" x D28.2" x H60.3")
Net weight	530lbs (Depends on configuration)
Power supply	Single phase 110- 120VAC, 50/60Hz, 3.6-3.3A
Power consumption	400W
Use temperature	23 to 104°F (-5 to 40°C)
Preservation temperature	-13 to 149°F (-25 to 60°C)
Use temperature humidity	45~85%RH
Preservation humidity	25~100%RH
Use the uplands	~1000M
One's tolerance level	200~240V +6%, -10%
Over voltage category	Category II according to IEC60664-1
Pollution degree	Degree 2 according to IEC60664-1

Keep this “Operation Manual” at an appointed place with care so that it may be available whenever required.

If this “Operation Manual” is stained or lost, make contact with the distributor or our salesman or customer service section to ask for a new operation manual after making sure of its contents.

When ordering consumables or parts, be sure to specify the machine model.